

LED Strobe Lights

SL-1301-EAQ

12 LEDs total, flash only

SL-1301-BAQ

32 LEDs total, 5 LED strips

Same as EAQ series plus adjustable flash speeds and patterns, and optional battery backup

SL-1301-SAQ

54 LEDs total, 10 LED strips

Same as BAQ series plus 100dB siren



Features:

- Utilizes high-intensity LEDs
- Operating life over 50,000 hours (over 5.7 years)
- Same size as the SL-126Q strobe light
- Simple 2-wire installation
- Weather resistant
- High-impact resistant case
- High-impact and heat-resistant lens
- Reverse polarity protection
- Visible in all directions
- 5 lens colors available:
Amber, Blue, Clear, Green and Red



Ordering Info:

Model	12 LED	32 LED	54 LED
Amber	SL-1301-EAQ/A	SL-1301-BAQ/A	SL-1301-SAQ/A
Blue	SL-1301-EAQ/B	SL-1301-BAQ/B	SL-1301-SAQ/B
Clear	SL-1301-EAQ/C	SL-1301-BAQ/C	SL-1301-SAQ/C
Green	SL-1301-EAQ/G	SL-1301-BAQ/G	SL-1301-SAQ/G
Red	SL-1301-EAQ/R	SL-1301-BAQ/R	SL-1301-SAQ/R

BAQ series also include all features of the EAQ plus:

- 5 Vertical LED strips (32 LEDs total) increase visibility from various directions
- 6 different flashing options
- Adjustable flashing speed
- Backup battery available for continuous lighting applications

SAQ series also includes all features of the BAQ plus:

- 10 Vertical LED strips (54 LEDs total)
- Built-in 100dB siren (programmable)

Specifications:

Model	SL-1301-EAQ	SL-1301-BAQ	SL-1301-SAQ
Operating voltage	6~12 VDC	9~24 VDC	10~24 VAC/VDC
Current draw (max)¹	200mA	30~180mA	90~350mA
# of flash patterns²	1	6	6
Flashing speed	130 times/min	Adjustable 30~260 times/min	
Vertical LED strips	0	5	10
Total # of LEDs	12	32	54
Backup battery³	No	Yes	Yes
Operating temperature	-4°~144° F (-20°~65° C)		
Electrical protection	Reverse polarity protected		
Built-in siren	No	Yes (100dB)	
IP rating	IP66		IP55
Dimensions	3 ¹⁵ / ₁₆ "x2 ²⁹ / ₃₂ " (100x74mm)		

¹Depending on settings

²SL-1301-EAQ series has strobe only

³9VDC battery not included

SECO-LARM® U.S.A., Inc.

16842 Millikan Avenue, Irvine, CA, 92606

Phone: (949) 261-2999 | (800) 662-0800 Fax: (949) 261-7326

Website: www.seco-larm.com Email: sales@seco-larm.com











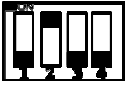
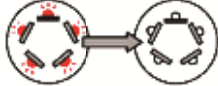
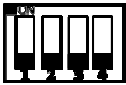

Copyright 2015 © SECO-LARM U.S.A., Inc. All rights reserved.

The SECO-LARM policy is one of continual development. For that reason, SECO-LARM reserves the right to change prices and specifications without notice. SECO-LARM is not responsible for misprints.

SECO-LARM® ENFORCER® CRIMEBUSTER® CBA SLI®

Pi_SL-1301-xAQ_150702.docx

Programmable Flashing Patterns (BAQ & SAQ models only):

DIP Switch Position	Flash Pattern Description (SL-1301-BAQ shown)	
1 	Strobe LEDs flash on and off continuously. (Default setting)	
2 	Rotate Clockwise Light rotates clockwise in a circular fashion continuously. (Beacon)	
3 	Steady ON All LEDs stay on. Ideal for continuous lighting applications.	
4 	Flash with Progressive ON LEDs turn on progressively clockwise until all LEDs are lit (sweep), and then turn off.	
5 	Rotate Back and Forth LED groups light up one at a time, rotating clockwise and counterclockwise.	
6 	Flash with Progressive ON/OFF LEDs turn on progressively clockwise (sweep), then turn off progressively counterclockwise.	

Dimensions:

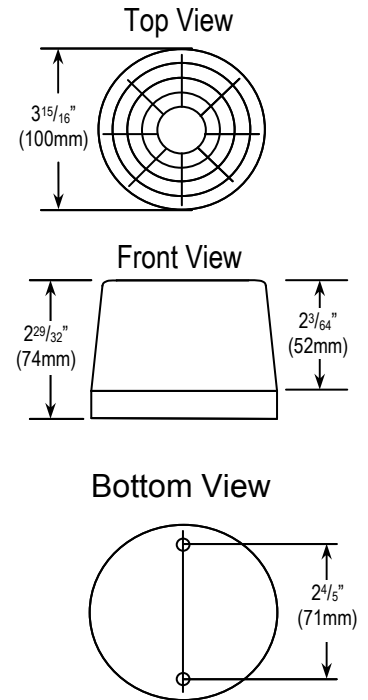

Also Available from SECO-LARM:

Note: The SL-1301 series LED strobe light has the same dimensions as the SL-126 series strobe light.

Replacement Lenses
SL-126LQ/X
(Replace "X" with the first letter of the desired color)



Available in Red, Blue, Amber, Clear, or Green

Mounting Options

Conduit Drop
SL-1901-DAQ



Conduit Box
SL-1901-JAQ



Application Photos

Conduit Drop



Conduit Box



Both



Xeon Tube Strobe Lights
SL-126Q Series



Available in Red, Blue, Amber, Clear, or Green

SECO-LARM® U.S.A., Inc.

16842 Millikan Avenue, Irvine, CA, 92606

Phone: (949) 261-2999 | (800) 662-0800 Fax: (949) 261-7326

Website: www.seco-larm.com Email: sales@seco-larm.com

Copyright 2015 © SECO-LARM U.S.A., Inc. All rights reserved.

The SECO-LARM policy is one of continual development. For that reason, SECO-LARM reserves the right to change prices and specifications without notice. SECO-LARM is not responsible for misprints.

SECO-LARM® ENFORCER® CRIMEBUSTER® CBA SLI®

Pi_SL-1301-xAQ_150702.docx

