

Specifications:

	SK-910RA	SK-910RAV	SK-910RAV2
Range	Up to 500' range	Up to 500' range	
Operating Voltage	11-24 V AC/DC (16--24 VAC/DC must cut LP4)	3-13.8 VDC	
Memory Capacity	15 transmitter button codes per channel		
Current Draw	5mA standby, 50mA LED flashing @ 12VDC	5mA standby, 15mA LED flashing @ 12VDC	
Output mode	Programmable 4-sec. momentary (default), 1-sec. momentary, toggle (ON/OFF), or validity		
Output type	3A Form 'C' relay (NO/NC/C).	Transistor GND x 1, 5A @ 12VDC	Transistor GND x 2, 3A @ 12VDC
Dimensions	3 ³ / ₁₆ " x 2 ⁹ / ₁₆ " x 3 ¹ / ₄ " (80 x 65 x 19 mm)		
Frequency	315MHz. (Other frequencies available. Please contact SECO-LARM.)		
Transmitter	Compatible with all SECO-LARM transmitters		

Compatible Transmitters

Fixed-Code: 68 billion codes. CODEBUMP™ code-hopping: 18 quintillion (1.8 x 10¹⁹) codes

Pendant Remotes

Model Number	# of Buttons	# of Channels	Coding	Blank or Pre-coded
SK-919TD1S-U	1	1	Fixed	Blank
SK-919TD1S-UP			Fixed	Pre-coded
SK-919TD2A-U	2	3	Fixed	Blank
SK-919TD2A-UP			Fixed	Pre-coded
SK-917T2A			Code Hopping	Pre-coded
SK-919TP3J-N	3	7	Fixed	Pre-coded
SK-917T3J			Code Hopping	Pre-coded
SK-919TP4J-N	4	15	Fixed	Pre-coded
SK-917TP4J-N			Code Hopping	Pre-coded

Hand-Held Remotes

Model Number	# of Buttons	# of Channels	Coding	Blank or Pre-coded
SK-919TP1H-B	1	1	Fixed	Pre-coded
SK-919TP2H-N	2	3	Fixed	Pre-coded
SK-919TP4H-N	4	15	Fixed	Pre-coded

Accessories

SK-9HBC	Belt clip holster for hand-held remotes
---------	---

CODEBUMP™
 With SECO-LARM's CODEBUMP, so-called code-grabbers and scanners are rendered obsolete because the RF code changes every time the transmitter button is pressed. In addition, with over 18 quintillion (1.8 x 10¹⁹) codes, the chances of ever repeating a code are virtually non-existent.
 SECO-LARM's CODEBUMP transmitters and receivers are perfect for controlling garage and gate openers, car and home alarms, plus much more.

WARRANTY: These ENFORCER RF receivers are warranted against defects in material and workmanship while used in normal service for a period of one (1) year from the date of sale to the original customer. Our obligation is limited to the repair or replacement of any defective part if the unit is returned, transportation pre-paid, to SECO-LARM.

Copyright © 2007 SECO-LARM U.S.A., Inc. All rights reserved. This material may not be reproduced or copied, in whole or in part, without the written permission of SECO-LARM.

The SECO-LARM policy is one of continual development and improvement. For this reason, SECO-LARM reserves the right to change specifications without further notice.

SECO-LARM® U.S.A., Inc.

16842 Millikan Avenue, Irvine, CA 92606
 Tel: 800-662-0800 / 949-261-2999 Fax: 949-261-7326

PITSW1
 Copyright © 2005 SECO-LARM U.S.A., Inc.
 Website: www.seco-larm.com
 E-mail: sales@seco-larm.com

Installation Manual

ENFORCER®

SK-910RA SERIES Miniature RF Receivers



SK-910RA
 Shown

- Up to 500 ft. range
- Operate on 11-24VAC/DC¹
- Code learning
- FCC compliant
- Fixed code or CODEBUMP™ code-hopping

Introduction

These mini RF receivers are compatible with both code hopping and fixed-code transmitters (see page 4 of this manual for a list of compatible transmitters). They can be used for a variety of applications, such as allowing the same transmitter to arm/disarm a vehicle alarm and open/close a garage door opener. The receivers come in one- or two-channel versions. Each channel can learn the codes of up to 15 different transmitter buttons on a first-in, first-out basis.

Installation Notes

1. Mount out of sight in a location where it is not surrounded by metal, and where it is not exposed to the weather or moisture. Metal will block the RF signal, resulting in a reduced range.
2. For best range, pull the antenna wire as straight and high as possible. If the receiver receives interference from local RF activity (eg., airport or military base), the antenna wire can be folded. DO NOT CUT THE ANTENNA WIRE.

Models Available

- SK-910RA** 1-channel mini-receiver, 3A Form "C" relay, 315MHz
- SK-910RAV** 1-channel mini-receiver, 5A transistor ground output, 315MHz
- SK-910RAV2** 2-channel mini-receiver, 3A transistor ground outputs, 315MHz
- SK-910RA-4** 1-channel mini-receiver, 3A Form "C" relay, 433.92MHz
- SK-910RAV-4** 1-channel mini-receiver, 5A transistor ground output, 433.92MHz
- SK-910RAV2-4** 2-channel mini-receiver, 3A transistor ground outputs, 433.92MHz

More RF receivers are available (1 to 4 channels). Contact SECO-LARM for details.

¹All models work on 11-24VAC/DC, except for the low voltage versions.

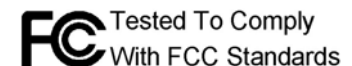

Learning a New Button Code (channel 1)

1. Press the mode switch which is located at the top of the receiver case for three seconds. The green LED will start to flash quickly.
2. While the green LED is flashing quickly, press a button on a compatible transmitter. The green LED will flash once and then turn off to show that button was learned.
3. Repeat steps 1 and 2 to learn more buttons into channel 1.

NOTE — The green LED will flash a maximum of 15 seconds. If no transmitter button is pressed during this time, the receiver will exit the code-learning mode, and the green LED will turn off.

Learning a New Button Code (channel 2, SK-910RAV2 only)

The procedure is the same as for channel 1, except mode switch #2 (black switch) initiates the code-learning process, and the red LED shows status. For two channel receivers, red color push-button represent mode switch #1 and black color push-button represent mode switch #2.

Note Regarding Code Learning

1. The receiver will only learn the code of a particular button once. Once a button's code is learned, if you try to code-learn that button again, whether it is for the same channel or not, the receiver will remain in the code learning mode. The LED will turn steady ON (1-sec.) to show the code is already in memory.
2. Each channel can learn the codes of a maximum of 15 transmitter buttons. If you attempt to learn a sixteenth button, the earliest code learned will be deleted and replaced by the new code (first-in, first out).
3. **To clear all codes** — To clear all codes in the channel's memory, press the appropriate mode switch (#1 or #2) for three seconds. When the LED starts flashing, press that switch again for three seconds. The LED flashes twice to indicate that all codes associated with that channel are now deleted.

Programming Output Modes (see table 1)

4-second momentary	Press the transmitter button once. The output turns on for 4 seconds, and then turns off. (This is the DEFAULT mode)
1-second momentary	Press the transmitter button once. The output turns on for 1 second, and then turns off.
Toggle	Press the transmitter button once, and the output turns on. Press a compatible transmitter button again, and the output turns off.
Validity	The relay turns on for as long as the transmitter button is pressed.

Mode Switch Operation (one per channel)

Learn mode	Press and hold the switch for three seconds. The appropriate LED will flash quickly to show that it is ready to learn a transmitter code.
Clear memory	Press three seconds, then when the appropriate LED starts flashing, press again for three seconds to delete all previously learned codes. The LED will flash twice to confirm codes deleted.
Memory Display	Press and immediately release the mode switch to show number of codes stored. The appropriate LED will flash a number of times to correspond to the number of codes stored.

LED Indication (one per channel)

Steady on	Senses signal from a transmitter button whose code was already learned.
Fast flash	In the code-learning mode.
One flash	A transmitter button code was learned.
Two flashes	All previously learned transmitter button codes were deleted.

SK-910RA

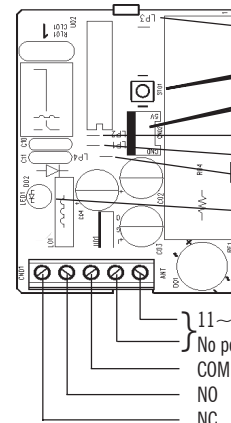

SK-910RAV/RAV2

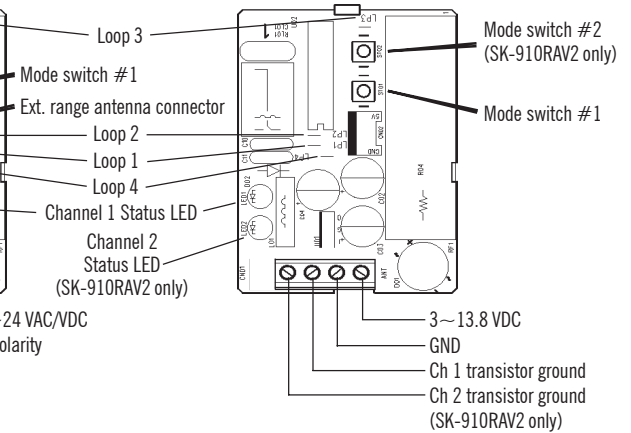

Table 1: To program outputs, open case and find the jumpers marked LP1, LP2, LP3, and LP4. Cut these jumpers, if needed, as follows:

	4-SEC. MOMENTARY	1-SEC. MOMENTARY	TOGGLE	VALIDITY
LP1	UNCUT	UNCUT	CUT	CUT
LP2	UNCUT	CUT	UNCUT	CUT
LP3	CUT LP3 TO USE EXTERNAL ANTENNA			
LP4	CUT LP4 FOR 16-24VAC/DC POWER INPUT (for SK-910RA only)			

NOTE — For the SK-910RAV2 2-channel model, the mode of both outputs is the same. In other words, you cannot have 4-second momentary output for channel 1 and a validity output for channel 2.

Typical Applications:

Positive or negative output:

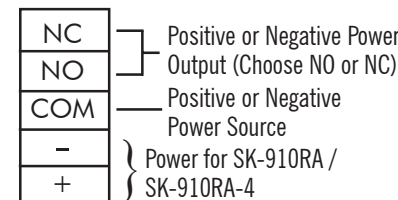

12VDC receiver power input, 24VAC output driving a motor

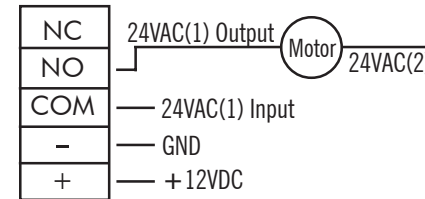

12VDC receiver power driving a 12VDC appliance

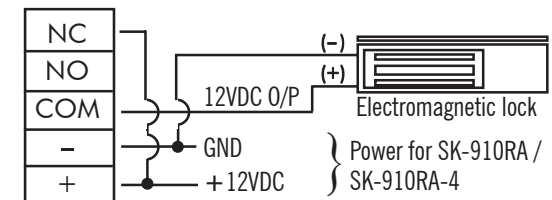

For SK-910RAV/SK-910RAV-4 and SK-910RAV2/SK-910RAV2-4

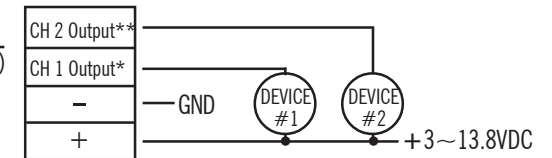

* For SK-910RAV / SK-910RAV-4
** For SK-910RAV2 / SK-910RAV2-4

Extended Range Antenna for SK-910RA only

The optional SK-91ERSD extends the RF receiver range to up to 1,200' (open air) with existing remotes. The antenna comes with a 9' cable which easily plugs into the 3-pin antenna port located on the RF receiver motherboard (see the illustration above).

IMPORTANT: If an extended range antenna is used with the SK-910RA, the receiver PC board loop marked "LP3" must be cut.

