

CBA[®]

RA-4961-PRQ

Wireless Indoor PIR Sensor

Manual



- For use with RA-4961 series receivers
- Wirelessly monitor entryways, rooms, or other areas
- Up to 1,000ft (305m) transmission range*
- Programmable activation time
- Runs on batteries for a convenient, wireless installation
- Adjustable mounting angle

*Transmission range will vary depending on installation and operating environment

SECO-LARM[®] SLI



CBA Wireless Indoor PIR Sensor

Specifications:

Model number		RA-4961-PRQ
Frequency		914.8MHz
Transmission range*		Up to 1,000ft (305m)
Channels		1
Power supply		1x 9VDC Battery (Not included)
Current draw	Standby	7 μ A
	Max	18mA
Estimated battery life		300 days (3 triggers/day)
Low battery indicator		Zone LED on receiver blinks continuously
PIR sensor range		26' (8m)
PIR sensor detection angle		80° horizontal
Operating temperature		-4°~140° F (-20°~60° C)
Dimensions		27/16" x 115/16" x 39/16" (62x49x90 mm)

*Transmission range will vary depending on installation and operating environment.

Parts List:

1x Wireless indoor PIR sensor 1x Sensor Bracket 2x Screws 2x Screw anchors 1x Manual

Dimensions:

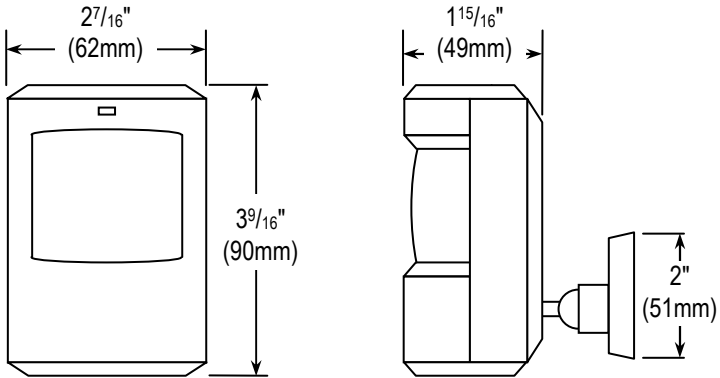

Overview:

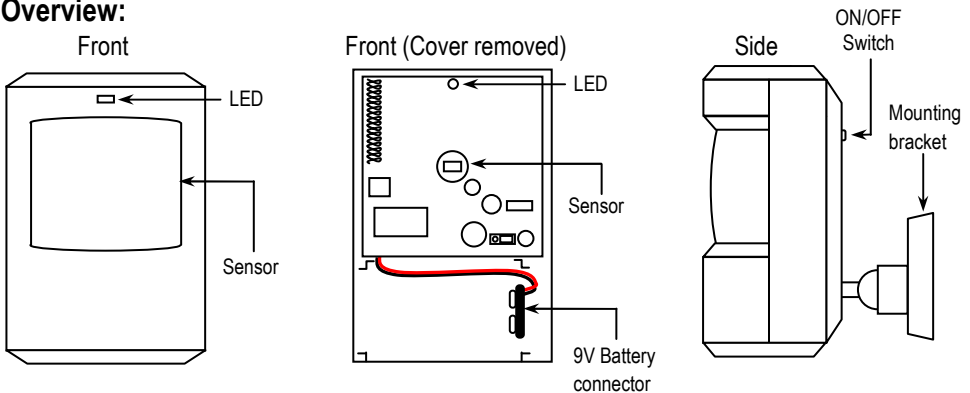

Installation:

1. Select the location where the sensor will be mounted.
2. The sensor should be mounted 6~9ft (2~3m) above the ground, have a clear view of the desired detection area, and be safe from water.
3. Use the two included mounting screws to mount the sensor bracket to the surface.
4. Slide the sensor down onto the bracket.
5. Point the sensor toward the desired detection area.

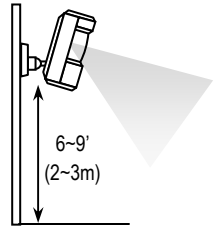

Programming the Sensor:

Removing the Cover

1. To access the timer programming and install/change the battery, the cover of the sensor must be removed.
Note: Remove the sensor from the bracket before removing the cover.
2. Push down behind the tab on the top of the sensor and carefully pull the cover away from the sensor body.

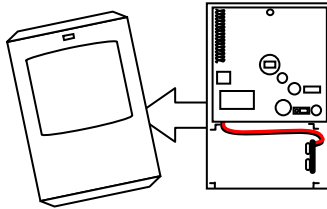

Programming the Sleep Timer

1. Use the DIP Switch to program the sleep timer to 5 seconds or 5 minutes. The sensor will not reactivate for the set amount of time after the sensor is triggered.

5 Minutes



5 Seconds*

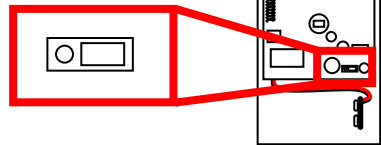

*Default setting

Pairing the Sensor:

1. Follow the pairing instructions for the RA-4961-K1Q receiver or RA-4961-VPQ wireless receiver to enter the pairing mode. (Refer to the RA-4961-K1Q or RA-4961-VPQ manual for detailed instructions).
2. Turn the sensor on and wait up to 15 seconds for the PIR to begin sensing.
3. Wave a hand in front of the sensor to activate it for pairing.
4. The receiver will beep once and cycle to the next channel to confirm successful pairing.

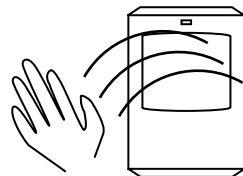

CBA Wireless Indoor PIR Sensor

Installing the Battery:

1. Remove the cover by pushing down behind the tab on the top of the sensor and carefully pulling the cover away from the sensor body.
2. Connect a 9V battery to the battery connector.
3. Replace the cover.

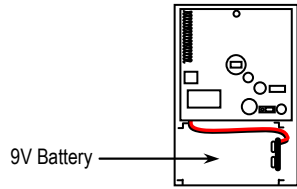

Note: Low battery is indicated on the receiver. Refer to the RA-4961-K1Q or RA-4961-VPQ manual for more information.

Also Available from SECO-LARM:



Wireless
Alert System
RA-4961-K1Q



Wireless
Outdoor PIR Sensor
RA-4961-DSQ



Wireless
Magnetic Contact
RA-4961-MCQ



Wireless
Pushbutton
RA-4961-PBQ



Wireless
Vibrating Receiver
RA-4961-VPQ



Wireless
Mailbox/Tilt Sensor
RA-4961-MBQ

FCC COMPLIANCE STATEMENT:

FCC ID: YAHHAX-900

THIS DEVICE COMPLIES WITH PART 15 OF THE FCC RULES. OPERATION IS SUBJECT TO THE FOLLOWING TWO CONDITIONS: (1) THIS DEVICE MAY NOT CAUSE HARMFUL INTERFERENCE AND (2) THIS DEVICE MUST ACCEPT ANY INTERFERENCE RECEIVED, INCLUDING INTERFERENCE THAT MAY CAUSE UNDESIRE OPERATION. Notice: The changes or modifications not expressly approved by the party responsible for compliance could void the user's authority to operate the equipment. IMPORTANT NOTE: To comply with the FCC RF exposure compliance requirements, no change to the antenna or the device is permitted. Any change to the antenna or the device could result in the device exceeding the RF exposure requirements and void user's authority to operate the device.

LIMITED WARRANTY: This SECO-LARM product is warranted against defects in material and workmanship while used in normal service for one (1) year from the date of sale to the original customer. SECO-LARM's obligation is limited to the repair or replacement of any defective part if the unit is returned, transportation prepaid, to SECO-LARM. This Warranty is void if damage is caused by or attributed to acts of God, physical or electrical misuse or abuse, neglect, repair or alteration, improper or abnormal usage, or faulty installation, or if for any other reason SECO-LARM determines that such equipment is not operating properly as a result of causes other than defects in material and workmanship. The sole obligation of SECO-LARM and the purchaser's exclusive remedy, shall be limited to the replacement or repair only, at SECO-LARM's option. In no event shall SECO-LARM be liable for any special, collateral, incidental, or consequential personal or property damage of any kind to the purchaser or anyone else.

NOTICE: The information and specifications printed in this manual are current at the time of publication. However, the SECO-LARM policy is one of continual development and improvement. For this reason, SECO-LARM reserves the right to change specifications without notice. SECO-LARM is also not responsible for misprints or typographical errors. Trademarks are the property of SECO-LARM USA Inc. or their respective owners.

Copyright © 2015 SECO-LARM U.S.A., Inc. All rights reserved. This material may not be reproduced or copied, in whole or in part, without the written permission of SECO-LARM.

SECO-LARM® U.S.A., Inc.

16842 Millikan Avenue, Irvine, CA 92606
Phone: (949) 261-2999 | (800) 662-0800

Website: www.seco-larm.com
Email: sales@seco-larm.com



MiRA-4961-PRQ_150916.doc