

Troubleshooting:

Auto dialer will not arm/disarm	<ul style="list-style-type: none"> • Make sure that you have entered the correct PIN Number. Try re-entering it. • While pressing and holding the [PROG] button, use a pen or paper clip to press the [RESET] button on the back of the dialer. This sets the PIN number to the default (000). Then try to arm/disarm again.
Auto dialer will not dial out	<ul style="list-style-type: none"> • Make sure that the telephone line is working. • Make sure that you have programmed at least one telephone number into the unit and that the full number has been stored. • Make sure that the system is in Auto Dial mode.
Unit doesn't respond to a call-back	<ul style="list-style-type: none"> • Check to see if another unit (fax or answering machine) could be answering the call and remove the other unit. • Adjust the call-in ring detect setting so that the auto dialer will answer.
Difficulty in activating 'room monitor' by telephone remote control	<ul style="list-style-type: none"> • Try pressing the code key again. • Move to a quieter location as ambient noise may affect the auto dialer's ability to detect the tone signal.

NOTE: While the system can provide valuable protection to home and property when properly installed, it cannot guarantee complete protection against intrusion. SECO-LARM is not responsible for any losses or damage which may occur during the use of this product.

IMPORTANT: Users and installers of this product are responsible for ensuring this product complies with all national, state, and local laws and statutes related to monitoring and recording audio and video signals. SECO-LARM will not be held responsible for the use of this product in violation of any current laws or statutes.

WARRANTY: This SECO-LARM product is warranted against defects in material and workmanship while used in normal service for one (1) year from the date of sale to the original customer. SECO-LARM's obligation is limited to the repair or replacement of any defective part if the unit is returned, transportation prepaid, to SECO-LARM. This Warranty is void if damage is caused by or attributed to acts of God, physical or electrical misuse or abuse, neglect, repair or alteration, improper or abnormal usage, or faulty installation, or if for any other reason SECO-LARM determines that such equipment is not operating properly as a result of causes other than defects in material and workmanship. The sole obligation of SECO-LARM and the purchaser's exclusive remedy shall be limited to the replacement or repair only, at SECO-LARM's option. In no event shall SECO-LARM be liable for any special, collateral, incidental, or consequential personal or property damage of any kind to the purchaser or anyone else.

NOTICE: The information and specifications printed in this manual are current at the time of publication. However, the SECO-LARM policy is one of continual development and improvement. For this reason, SECO-LARM reserves the right to change specifications without notice. SECO-LARM is also not responsible for misprints or typographical errors.

Copyright © 2014 SECO-LARM U.S.A., Inc. All rights reserved. This material may not be reproduced or copied, in whole or in part, without the written permission of SECO-LARM.

SECO-LARM® U.S.A., Inc.

16842 Millikan Avenue, Irvine, CA 92606
 Phone: (949) 261-2999 | (800) 662-0800

Website: www.seco-larm.com
 Email: sales@seco-larm.com

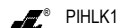

MIE-921APQ_141029.docx



**Auto Dialer
 Manual**



Models Available	Certification
E-921APQ	FC
E-921GPQ	CE

When triggered by an alarm system, the ENFORCER Auto Dialer can call up to 5 numbers. Each number can contain up to 32 digits, including #, tones, and pauses. The LCD shows the number being dialed at each stage of the dialing process. The receiver can then listen in to sounds in the room and disarm the system. The same functions are available by remote call in as well as arming the system. The dialer includes a home mode (acting like a door chime when the owner is present) and a panic button. The 105dB built-in siren alarm can be programmed on or off. It also allows for the option of a backup battery (not included) to continue offering protection during a power loss and uses flash memory to protect against system data loss in case of extended power failure.



Table of Contents:

Features	2	Setting the Date and Time	9
Parts List.....	3	Testing the Auto Dial Function.....	9
Specifications	3	Resetting the Auto Dialer.....	9
Wiring Diagram.....	3	Operating the Auto Dialer	10~13
Overview.....	4	Arming and Disarming the System	10
LCD Screen Layout	4	Panic Button Use	10
Installing the Auto Dialer.....	5	Remote Control by Telephone	11~12
Programming the Auto Dialer	6~9	Home Mode Use	12
Setting and Changing the PIN Number	6	Low-Battery Indicator	13
Setting Emergency Phone Numbers	6~7	View Function	13
Deleting a Stored Phone Number.....	7	Tips	13
Setting the Siren Function	7	Also Available from SECO-LARM®	13
Setting the Auto Dial Function	8	Program Planner.....	14
Setting the Number of Auto Dial Cycles	8	Summary Programming/Operation Chart	15
Setting the Number of Call-in Rings	8	Troubleshooting	16
Setting the Entry Delay Time	9		

Features:

- 16-Digit large display with date/time and function icons
- 2 (N.C.) Triggers for multiple zone security
- Remote monitoring – user can call in to listen in to room sounds and arm/disarm dialer
- Remotely listen in to room sounds or disarm during call back
- Programmable PIN number and entry delay timing
- 5 Programmable emergency telephone numbers (up to 32 digits each)
- Programmable auto-dialing cycle repeat times
- Home mode function (acts as a door chime when user is at home)
- Panic button
- Built-in flash memory to protect against system data loss in case of power failure
- Touch-Tone dialing
- Phone jack
- Low-battery indicator for backup battery (battery not included)
- DC power input jack (3.5mm phone jack, not included)
- 9V battery backup (battery not included)
- Wall-mountable
- Built-in 105dB alarm (with programmable alarm on/off)
- Built-in auxiliary output for external alarm or siren

Summary Programming/Operation Chart:

1. Setting/Changing PIN Number (see pg. 6)

Current PIN	[PROG]	[ARM/DISARM]	New PIN	[ARM/DISARM]	[PROG] x9
-------------	--------	--------------	---------	--------------	-----------

2. Setting Emergency Phone Numbers (see pgs. 6~7)

PIN	[PROG] x2	[ARM/DISARM]	[#/DOWN] or [*UP]	Enter Phone Number	[ARM/DISARM]	[PROG] x8
-----	-----------	--------------	-------------------	--------------------	--------------	-----------

3. Deleting a Stored Phone Number (see pg. 7)

PIN	[PROG] x2	[ARM/DISARM]	[#/DOWN] or [*UP]	[DELETE/PAUSE]	[ARM/DISARM]	[PROG] x8
-----	-----------	--------------	-------------------	----------------	--------------	-----------

4. Setting the Siren Function (see pg. 7)

PIN	[PROG] x4	[ARM/DISARM]	[#/DOWN] or [*UP]	[ARM/DISARM]	[PROG] x6
-----	-----------	--------------	-------------------	--------------	-----------

5. Setting the Auto Dial Function (see pg. 8)

PIN	[PROG] x5	[ARM/DISARM]	[#/DOWN] or [*UP]	[ARM/DISARM]	[PROG] x5
-----	-----------	--------------	-------------------	--------------	-----------

6. Setting the Number of Auto Dial Cycles (see pg. 8)

PIN	[PROG] x6	[ARM/DISARM]	[#/DOWN] or [*UP]	[ARM/DISARM]	[PROG] x4
-----	-----------	--------------	-------------------	--------------	-----------

7. Setting the Number of Call-in Rings (see pg. 8)

PIN	[PROG] x7	[ARM/DISARM]	[#/DOWN] or [*UP]	[ARM/DISARM]	[PROG] x3
-----	-----------	--------------	-------------------	--------------	-----------

8. Setting the Entry Delay Time (see pg. 9)

PIN	[PROG] x8	[ARM/DISARM]	[#/DOWN] or [*UP]	[ARM/DISARM]	[PROG] x2
-----	-----------	--------------	-------------------	--------------	-----------

9. Setting the Date/Time (see pg. 9)

PIN	[PROG] x9	[ARM/DISARM]	[#/DOWN] or [*UP]	[ARM/DISARM]	Repeat for each position	[PROG] x2
-----	-----------	--------------	-------------------	--------------	--------------------------	-----------

10. Test Auto Dial Function (see pg. 9)

(In Standby Mode)	Press and Hold [PROG]	[#/DOWN] or [*UP]	Check to see if number is dialed
-------------------	-----------------------	-------------------	----------------------------------

11. Arm/Disarm System (see pg. 10)

PIN	[ARM/DISARM]
-----	--------------

12. Remote Control by Telephone (see pgs. 11~12)

Receive Call	Press Key Code on Telephone Keypad
Dial Voice Dialer Number	Press Key Code on Telephone Keypad

13. Activate/Deactivate Home Mode (see pg. 12)

(In Standby Mode)	[HOME]
-------------------	--------

14. View (see pg. 13)

Last 5 Sensor Trigger Records	(In Standby Mode)	[#/DOWN]
Stored Emergency Telephone Numbers	(In Standby Mode)	[*UP]

Program Planner:

Use these charts during setup to record phone numbers and sensor locations for future reference. It is recommended that you use a pencil during setup and redo it in ink afterwards. The user should keep in a safe, easily accessible location and a copy should be retained by the installer.

Program: Numbers

Date:

NUMBER PRIORITY	TELEPHONE NUMBER (include area code and dialer prefix as needed, add PBX pause and extension if applicable, see p. 6-7)	NAME OF PARTY TO BE REACHED
1		
2		
3		
4		
5		
For Future Use		

Installation: Triggers

Date:

TRIGGER	GENERAL DESCRIPTION	SENSOR LOCATIONS
1		
2		

Parts List:

- | | |
|------------------------------------|---------------------------------------|
| 1x Auto dialer unit | 1x Telephone cable |
| 1x Remote control instruction card | 1x Dual outlet telephone jack adapter |
| 2x Plastic wall anchors | 2x Wall mount screws |
| 1x Wall mounting template | 1x User manual |

Specifications:

Operating voltage	9~12 VDC	
Current draw Max. (at 12VDC)	Standby	5mA
	Dialing	10mA
	Alarm On	180mA
Programmable emergency phone numbers	5	
Maximum digits per telephone number	32	
Backup battery type/life (not included)	9VDC/≈20h	
Alarm sound level at 12" (30cm)	≥105dB	
Trigger inputs	2 x N.C. Trigger	
Trigger input timer	≥500ms	
Auxiliary output current (max)	125mA	
Operating temperature	32°~104°F (0°~40°C)	
Storage temperature	-4°~140°F (-20°~60°C)	
Weight	6.2-oz (175g)	
Dimensions	3 ³ / ₈ "x4 ⁵ / ₁₆ "x1 ⁷ / ₈ " (86x110x47 mm)	

Wiring Diagram:

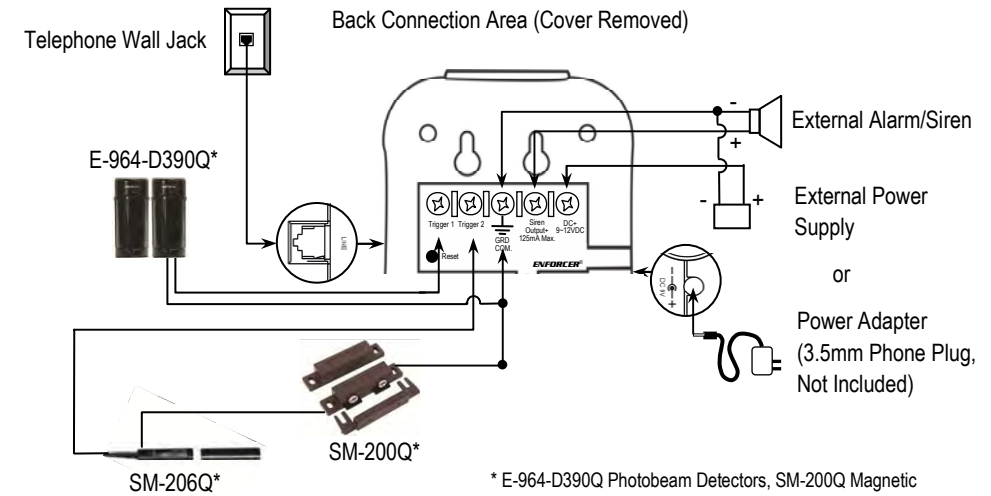

* E-964-D390Q Photobeam Detectors, SM-200Q Magnetic Sensors, and SM-206Q Concealed Magnetic Sensors shown as examples only. For other sensors and products available from SECO-LARM, please visit our website at www.seco-larm.com.

Overview:

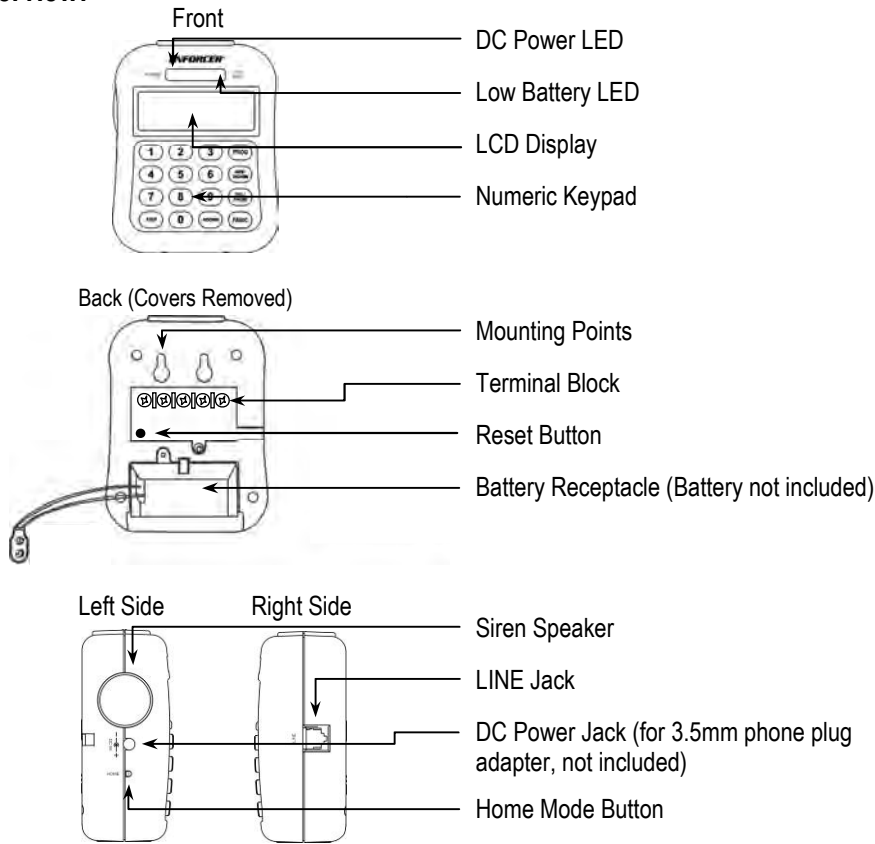

LCD Screen Layout:

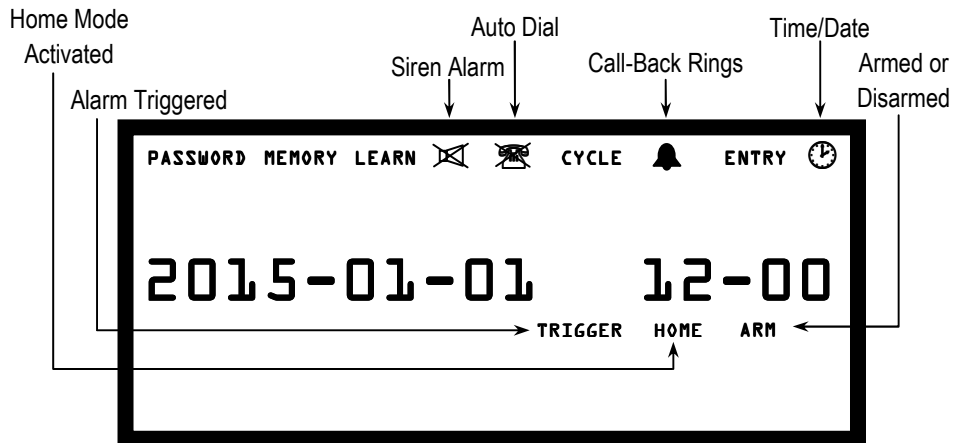

Note: For explanation of these symbols, please see **Programming the Auto Dialer** on pages 6~9.

Operating the Auto Dialer, continued:

Low-Battery (LOW BATT.) Indicator

When the charge level of the 9VDC backup battery (not included) is low, the “LOW BATT.” LED will flash once every 1.5 seconds. Replace the battery in order to continue providing functionality during a temporary disruption in power.

Note: In order to avoid potential damage due to battery leakage, do not leave a low battery in the unit. Also, be sure to remove the battery if the unit is unused for a period of time.

View Function

To view the last 5 sensor trigger events, while in standby mode press the [#/DOWN] button.





To view stored emergency telephone numbers, while in standby mode press the [*/UP] button.

Note: After 10 seconds of inactivity, the dialer will automatically exit the view mode and return to standby.

Tips:

1. Make sure that the full telephone numbers have been stored as they would normally be dialed from a local phone.
2. The auto dialer is only suitable for single phone lines. It is not compatible with fax machines.
3. Set the number of Call-in rings to be less than the voicemail or message answer point.

Also Available from SECO-LARM®:

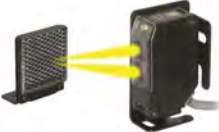
<p>LED Strobe Light SL-1301-BAQ</p> 	<p>Door/Window Switches, Magnetic Contacts, etc.</p> 	<p>Voice Dialer E-921CPQ</p> 
<p>Shock/Vibration Detector SS-040Q</p> 	<p>Tamper Switch SS-072Q</p> 	<p>Photobeam Sensor E-931-S35RRQ</p> 

For a complete listing of SECO-LARM products, please visit us online at www.seco-larm.com.

Operating the Auto Dialer, continued:

Remote Control by Telephone – Function Explanations, continued:

END CALL - Pressing [3 #] will end the call.

ARM SYSTEM – Pressing [5 #] during a user callback will arm the system, confirming with three short “beeps,” and automatically hang up. If there are 5 rapid “beeps” after three short “beeps,” it means a door/window is not closed. The dialer will then give 5 seconds to disarm the system.

DISARM SYSTEM – Pressing [6 #] will disarm the system and automatically hang up.

Note: If the user enters an incorrect password or key code, the dialer will sound 5 “beeps” and automatically hang up.

Home Mode Use

To turn off the alarm function and use the dialer as a door chime, set the dialer to “Home” mode. A chime will ring any time one of the sensors is triggered.

To activate the “Home” mode:

1. Press the [HOME] button on the left side of the dialer. One chime will sound and the word ‘HOME’ will appear on the LCD screen.
2. After 60 seconds, another chime indicates that the dialer is now in the “Home” mode.
3. When a sensor is activated, the dialer will chime twice.
4. If the panic button is pressed, the dialer will sound a 30-second alarm and start the dialing sequence to the programmed emergency numbers.

To deactivate the “Home” mode, simply press the [HOME] button again.

Note: Arming the system deactivates the “Home” mode. After disarming, reactivate the “Home” mode if desired.

Installing the Auto Dialer:

Note: You can program the telephone numbers and voice messages prior to connecting the power as long as the 9V battery is installed. The standby battery should provide about 20 hours of operation.

Note: The Auto Dialer uses EEPROM to retain memory in the event of a power loss.

1. Select a location for the dialer near a standard electrical outlet (if user-supplied 12VDC adapter is to be used), a telephone wall jack, and the alarm control panel, but out of sight. The dialer should not be exposed to direct sunlight or rain, and must not be mounted near heat sources such as radiators, heating ducts, or stoves.
2. For wall-mount, use the wall mounting template to drill holes and attach 2 screws into the wall at the desired location. For convenience, 5~6ft (1.5~2m) above the floor is recommended (Fig. 1).
3. Remove the cable cover and battery cover from the back of the auto dialer (Fig. 2).
4. Install a 9VDC backup battery (not included). Reattach the battery cover.
5. Connect the dialer to two detectors or groups of detectors in series using the connection terminals as shown in the wiring diagram (see pg. 3). The dialer can also be connected to two separate alarm control panel outputs of a separate alarm system. If an external siren/alarm is desired, connect as shown on the wiring diagram.

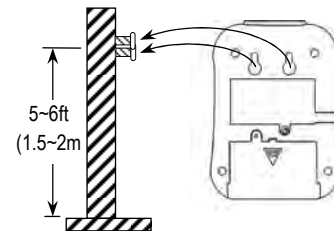

Fig. 1

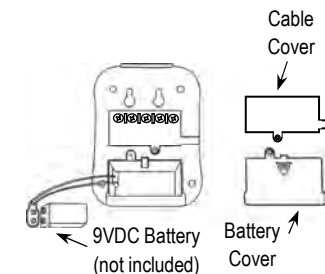

Fig. 2

6. Power:
 - a. If the dialer is to be powered from the alarm control panel, connect the alarm power outputs to the terminal block (see pg. 3).
 - b. If using a 12VDC adapter (not included), plug the adapter into the dialer's DC power jack.
7. Connect one end of the included telephone cable to an existing Touch-Tone line wall socket, and the other end to the dialer's “LINE” jack. Optionally, use the included dual outlet telephone jack adapter to connect an extension telephone using the telephone's cable (not included) (Fig. 3).
8. For wall installation, place the unit over the heads of the screws installed in step 2 (Fig. 1) and slide down. Check that the unit is firmly attached and tighten or loosen the screws as needed.
9. Once all connections are made, the dialer is ready to be programmed.

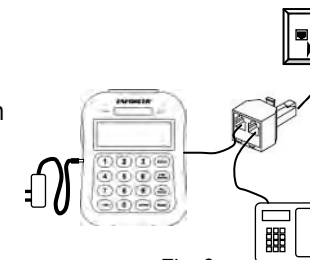

Fig. 3

Programming the Auto Dialer:

The setup mode may only be accessed when the dialer is in standby mode. If no key is pressed within 15 seconds, the dialer will automatically exit the setup mode.

Setting and Changing the PIN Number

1. Enter the current PIN number (factory preset PIN number is '000'), and press the [PROG] button once. 'PASSWORD' will flash on the LCD.
2. Press the [ARM/DISARM] button to accept.
3. Enter a new PIN number (3-6 digits) followed by the [ARM/DISARM] button to confirm.
4. Press the [# / DOWN] or [* / UP] button to select other setup categories or press the [PROG] button until the programming icons disappear to exit the setup mode.

Note: If the PIN number is forgotten, press and hold the [PROG] button and use a pen or paper clip to press the [RESET] button located under the cable cover on the back of the unit and release. The unit will return to the factory preset PIN number (000). All other user programmed settings except the date and time will be retained.

Setting Emergency Phone Numbers

1. Enter the PIN number and press the [PROG] button twice or until "MEMORY" flashes on the LCD screen.
2. Press the [ARM/DISARM] button to accept.
3. Press the [# / DOWN] or [* / UP] button to select one of the number locations 1-5.

Note: The 5 number locations represent the order in which the numbers will be dialed in the case of an alarm.

4. Enter the number to store including any area codes or dialing prefixes if needed (up to 32 digits, although only the last 16 digits can be shown on the LCD display) using the keypad followed by the [ARM/DISARM] button to accept and store the number.

Note: If needed, add a 4-second 'pause' before a PBX extension number by pressing and holding the [DEL/PAUSE] button for 2 seconds until the letter 'F' appears on the LCD screen, and then continuing with the extension number as usual. A '#' or '*' can also be entered by pressing, and holding for two seconds, the [# / DOWN] or [* / UP] buttons respectively. The '#' sign shows as 'L' and the '*' sign shows as 'I' on the LCD screen.

Example 1 – To store a number with area code 1-214-555-2858 and an office extension 205 (where the PBX requires a 2-second pause before the extension): After scrolling to the desired number location, enter '12145552858,' press the [DEL/PAUSE] button for 2 seconds until the letter 'F' appears on the LCD screen, enter '205' and press the [ARM/DISARM] button.

Operating the Auto Dialer, continued:

Remote Control by Telephone

The system can be remotely controlled and monitored through any Touch-Tone phone, including mobile phones. The user may arm or disarm the system as well as listen in on the room.

1. *REMOTE CONTROL WHEN ALARM IS ACTIVATED*

When an alarm has been activated and the auto dialer dials the pre-programmed emergency numbers, the person who answers the call will hear a single "beep" for a sensor trigger or 4 "beeps" for panic button activation and may press one of the following function codes at any time to control the system remotely:

Function	Press key code
Listen in	1 #
End call	3 #
Disarm system	6 #

The user should hear a "beep" in response. If not, enter the function code again.

2. *REMOTE CONTROL BY USER CALL-IN (CALL BACK)*

- A. Using a mobile phone or any Touch-Tone phone, dial the phone number that the auto dialer is connected to. The auto dialer will answer and "beep" once after the number of rings in the pre-programmed call-in ringer detect cycle (3, 5, 7, or 10 rings, see pg. 8).
- B. Enter the PIN Number on the phone's keypad. The dialer will "beep" twice if the correct code has been entered. If a wrong code is entered, the dialer will disconnect automatically and the user must dial in again.
- C. Press one of the following function codes to control the system remotely:

Function	Press key code
Listen in	1 #
Arm system	5 #
Disarm system	6 #

The user should hear a "beep" in response. If not, enter the function code again.

Note: Should the user have difficulty activating functions remotely by telephone, there may be too much ambient noise interference. Try pressing the code key again, or move to a quieter location as ambient noise above 68dB may affect the auto dialer's ability to detect the tone signal.

3. *FUNCTION EXPLANATIONS*

LISTEN IN – Pressing [1 #] allows a user to hear sound in the room for 50 seconds. A "beep" will sound at 30 seconds to remind the user that the listen in time will soon end. Pressing [1 #] again will reset the 50-second period, and entering any other key code will end monitoring and perform the function. If there is no other key press, the call will disconnect at the end of the 50 seconds.

Operating the Auto Dialer:

Arming and Disarming the System:

1. To **arm the system**, enter the PIN number and press the [ARM/DISARM] button.

The dialer will sound three short “beeps” and the words “ARM” will appear on the LCD screen. After 60 seconds, there will be a single “beep” tone to indicate that exit delay time has passed and the alarm is now fully armed.

After the delay, when the system is fully armed, if a door or window connected to the alarm is opened, the LCD screen will flash the word “TRIGGER”. After the adjustable entry delay time has passed, the siren will begin to sound (30 seconds on and 30 seconds off) and auto dialing will commence according to the programmed sequence and cycle times. The call receiver will hear a single “beep” to indicate a sensor has been triggered or 4 “beeps” to indicate the [PANIC] button has been pressed.

Note: When the siren has been programmed to “SOUND OFF,” the siren will not sound and the dialing will commence silently after the delay time has passed. When the call is answered, the receiver will hear single “beep” to indicate a sensor has been triggered or 4 “beeps” to indicate the [PANIC] button has been pressed.

Note: If the auto dialer is not connected to a working telephone line, the dialer will “beep” 4 times and the siren will begin to sound without attempting to continue dialing out (this overrides the “SOUND OFF” setting).

2. To **disarm the system**, enter the PIN number and press the [ARM/DISARM] button.

The dialer will sound a long “beep” and the word “ARM” will disappear from the LCD screen.

Panic Button Use

1. When the [PANIC] button is pressed, the siren will sound immediately and auto dialing will commence without delay. If the siren has been programmed to “SOUND OFF” the siren will not sound, but silent dialing will commence.
2. To cancel the alarm and stop auto dialing, enter the PIN number and press the [ARM/DISARM] button. The dialer is now disarmed.

Programming the Auto Dialer, continued:

Example 2 – To store a number with area code 1-949-555-1234, and an office extension #200 (where the PBX requires a 2-second pause before the extension): After scrolling to the desired number location, enter ‘19495551234,’ press the [DEL/PAUSE] button for 2 seconds until the letter ‘F’ appears on the LCD screen, press the [#/DOWN] button for 2 seconds until the ‘J’ appears on the LCD screen, enter ‘200,’ and press the [ARM/DISARM] button.

Example 3 – To store a local number 555-2858: After scrolling to the desired number location, enter ‘5552858’ and press the [ARM/DISARM] button.

5. Repeat for the other numbers to be stored (up to 5 total).
6. Press the [#/DOWN] or [*/UP] button to select other setup categories or press the [PROG] button until the programming icons disappear to exit the setup mode.

Note: If the dialer is programmed to call a voice pager service which requires operator assistance, the service should be notified in advance regarding the meaning of the message. Consult local authorities concerning the permissibility of automatically dialing their emergency numbers before programming.

Deleting a Stored Phone Number

1. Enter the PIN number and press the [PROG] button twice or until “MEMORY” flashes on the LCD screen.
2. Press the [ARM/DISARM] button to accept.
3. Press the [#/DOWN] or [*/UP] button to select the number you wish to delete.
4. Press the [DEL/PAUSE] button to delete the number.
5. Press the [#/DOWN] or [*/UP] button to select other setup categories or press the [PROG] button until the programming icons disappear to exit the setup mode.

Learn

This function is unused.

Setting the Siren Function

This setting allows the user to choose between an audible alarm when triggered, or a ‘silent alarm’ while dialing the emergency numbers. The factory default is “ON”.

1. Enter the PIN number and press the [PROG] button four times or until the alarm icon () flashes on the LCD screen.
2. Press the [ARM/DISARM] button to accept. The dialer will “beep” once.
3. Press the [#/DOWN] or [*/UP] button to select either “SOUND ON” or “SOUND OFF” and press the [ARM/DISARM] button to accept.
4. Press the [#/DOWN] or [*/UP] button to select other setup categories or press the [PROG] button until the programming icons disappear to exit the setup mode.

Programming the Auto Dialer, continued:**Setting the Auto Dial Function**

The user can choose whether or not the dialer will dial the emergency numbers when triggered. The factory default is "ON".

1. Enter the PIN number and press the [PROG] button five times or until the phone icon (☎) flashes on the LCD screen.
2. Press the [ARM/DISARM] button to accept.
3. Press the [#DOWN] or [*UP] button to select either "ON" or "OFF" and press the [ARM/DISARM] button to accept. The dialer will "beep" once.
4. Press the [#DOWN] or [*UP] button to select other setup categories or press the [PROG] button until the programming icons disappear to exit the setup mode.

Note:

1. When the dialer is in standby mode and the (☎) icon is ON, the auto dial is disabled.
2. When the dialer is in standby mode and the (☎) icon is OFF, the auto dial is enabled.

Setting the Number of Auto Dial Cycles

This can be set from 1~5 cycles. The factory default is 1 cycle, meaning that the auto dialer will dial each programmed number 1 time.

1. Enter the PIN number and press the [PROG] button six times or until "CYCLE" flashes on the LCD screen.
2. Press the [ARM/DISARM] button to accept.
3. Press the [#DOWN] or [*UP] button to select your choice of 1-5 cycles and press the [ARM/DISARM] button to accept. The dialer will "beep" once.
4. Press the [#DOWN] or [*UP] button to select other setup categories or press the [PROG] button until the programming icons disappear to exit the setup mode.

Setting the Number of Call-in Rings

This sets the number of call-in rings after which the auto dialer will answer. The factory default is 5 rings, but can be user programmed for 3, 5, 7, or 10 rings.

1. Enter the PIN number and press the [PROG] button seven times or until the bell icon (🔔) flashes on the LCD screen.
2. Press the [ARM/DISARM] button to accept.
3. Press the [#DOWN] or [*UP] button to select 3, 5, 7, or 10 and press the [ARM/DISARM] button to accept. The dialer will "beep" once.
4. Press the [#DOWN] or [*UP] button to select other setup categories or press the [PROG] button until the programming icons disappear to exit the setup mode.

Programming the Auto Dialer, continued:**Setting the Entry Delay Time**

This allows the user to set the length of time before the alarm will sound, to allow time to disable the alarm after normal entry. The factory default is 20 seconds, but can be user programmed for 0, 5, 10, 15, or 20 seconds.

1. Enter the PIN number and press the [PROG] button eight times or until "ENTRY" flashes on the LCD screen.
2. Press the [ARM/DISARM] button to accept.
3. Press the [#DOWN] or [*UP] button to select 0, 5, 10, 15, or 20 seconds and press the [ARM/DISARM] button to accept. The dialer will "beep" once.
4. Press the [#DOWN] or [*UP] button to select other setup categories or press the [PROG] button until the programming icons disappear to exit the setup mode.

Setting the Date and Time

1. Enter the PIN number and press the [PROG] button nine times or until the clock icon (🕒) flashes on the LCD screen.
2. Press the [ARM/DISARM] button to accept.
3. The date and time will appear on the LCD screen as 5 sets of numbers representing the year, month, date, hour, and minute respectively. The first set of numbers (year) will be flashing, indicating that this can now be changed.
4. Press the [#DOWN] or [*UP] button to select the correct number for the year and press the [ARM/DISARM] button to accept and move to the next position. Repeat for each position until complete.
5. Press the [PROG] button until the programming icons disappear to exit the setup mode.

Note: Time is shown using a 24 hour clock.

Testing the Auto Dial Function:

To test the auto dial function, while in standby mode, press and hold the [PROG] button for at least two seconds. When you hear a 'beep' tone, enter the memory location (1~5) of the number you wish to test. The auto dialer should then dial the chosen number.

Resetting the Auto Dialer:

To reset the Auto Dialer, press and hold the [PROG] button and use a pen or paper clip to press the [RESET] button located under the cable cover on the back of the unit and release. The unit will return to the factory preset PIN number (000). All other user programmed settings except the date and time will be retained.