



WIRELESS 2000 Annunciator System

REPEATER

TR-20U INSTALLATION INSTRUCTIONS

Please read this manual carefully before installation.

FEATURES

- Compatible with RC-20U (Chime box W/Relay), TD-20U (Indoor/Outdoor Sensor Transmitter), TS-10U (Hand-Held Transmitter), TC-10U (Door/Window Transmitter) and also compatible with any units of WIRELESS1000 series.
- Identifies the channel (location) by LED lights (4 channels).
- Able to learn 4 transmission codes.
- Automatic "Learning" function facilitates to preset transmission codes to TR-20U.
- Over 8 million codes possible, eliminates interference from neighbors.
- Low battery indicator to recognize transmission units' battery status.
- Powered by a 9VDC adaptor (Included).

① CAUTION AND WARNING

WARNING

- 1. Harsh environments**
Do not use the TR-20U outdoors, severe conditions as out of warranted temperature, rapid temperature change, high humidity, or steam. This may cause the unit to malfunction.
- 2. Tampering**
Any changes or modifications not expressly approved by OPTEX could void the user's authority to operate the equipment.
- 3. Adaptor**
Do not use any other AC adaptor except what is included.

CAUTION

- 1. Impact/Shock**
Impact or Shock can cause severe damage or break the TR-20U.
- 2. Electric Devices**
Use TR-20U at least 3ft (1m) away from electronic devices such as TVs, Radios, PCs, Microwave ovens, or any other device with an electric motors. This may cause the unit to malfunction.
- 3. Transmission range**
Transmission range may decrease under the following conditions:
 - Either transmission units or TR-20U installed on a metal surface.
 - Presence of a steel door, reinforced concrete or other metal obstructions between transmission unit and TR-20U.
 - Places near strong radio sources such as broadcast stations or substation.
- 4. Cleaning**
Harsh cleaners such as paint removers or benzene may ruin the surface. Use a soft wet cloth and mild soap to clean.

② PARTS IDENTIFICATION

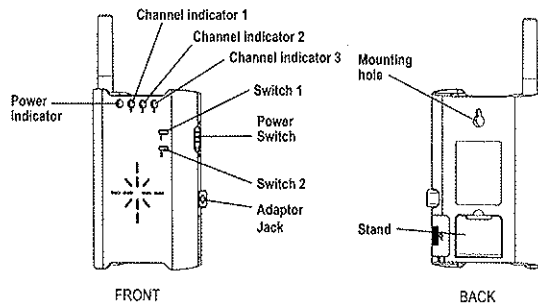

Function

Switch 1	Activating "LEARN MODE" and "TEACH MODE"
Switch 2	Activating for making selection

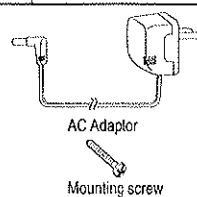

③ RECEPTION/ TRANSMISSION (REFERENCE)

Reception/Transmission range must be changed according to environment. Please check if system works properly for the site. In the case of insufficient transmission range, add another TR-20U (Repeater unit) to extend range.

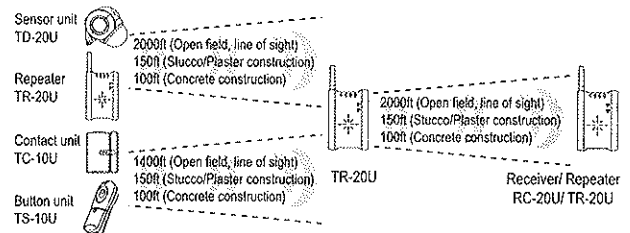

Note: When you recycle this product, please disassemble product and recycle according to state law.

④ INSTALLATION

Wall Mounting

Use the mounting screw on a wall. Leave some length of the screw out for mounting hole of the TR-20U.

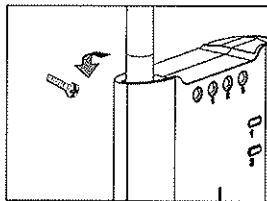

Desktop

Pull out the stand on the back of the TR-20U and place it on any flat surface.

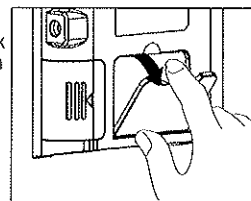

⑤ POWER CONNECTION

Use only the power adaptor supplied with the product.

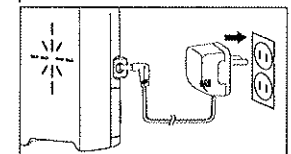

⑥ TEACH TRANSMITTER CODES TO TR-20U "LEARN MODE"

Each transmitter has a unique transmitter code which can be automatically learned by TR-20U. The TR-20U's channels must be taught to respond to the appropriate transmitter. (No transmitter is taught on default setting.)

Activate "LEARN MODE"

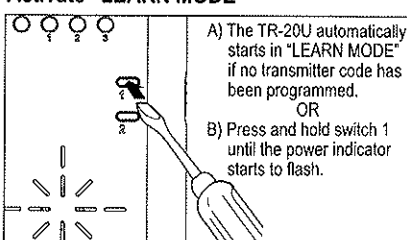

Teach the transmitter code to TR-20U

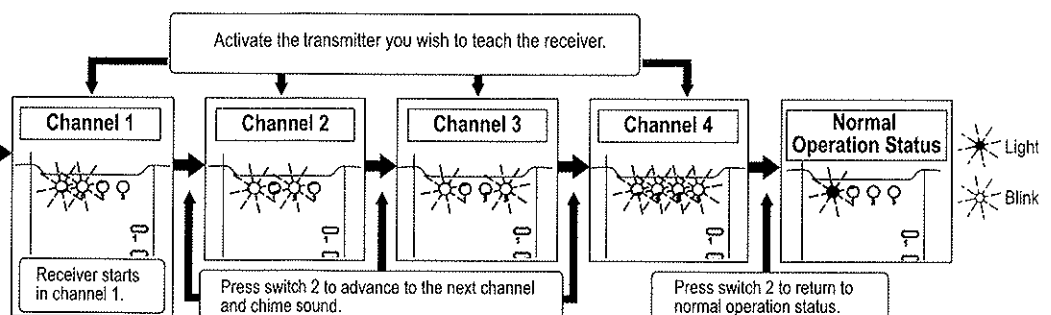

Note:

- Verify that each transmitter has been successfully learned by TR-20U by triggering them.
- Single transmitter cannot be learned by multiple channel.
- TR-20U learned code will keep memorized even if turning OFF the power.

Erasing codes from TR-20U's memory.

- 1) Hold down switch 1 until the power indicator starts to flash.
- 2) Press switch 2 until the appropriate channel indicator is lit.
- 3) Press switch 1 to erase. Channel indicator will start to flash.
- 4) Press switch 2 a few times until the power indicator stops flashing and remains lit.

Erasing all codes from TR-20U. (Return to the factory default)

To erase all programming, turn on power while holding switch 1.

⑦ TEACH TRANSMITTER CODES TO RECEIVER "TEACH MODE"

The receiver must be taught this transmitter code before use. Refer to the receiver's manual for details.

1. Preparation of receiver

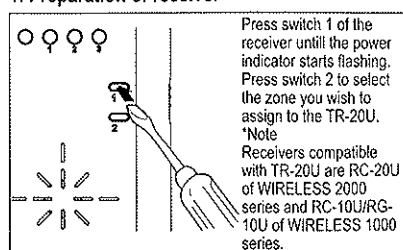

2. Activate "TEACH MODE"

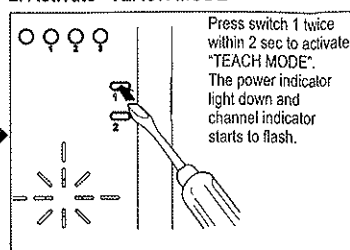

3. Select channel you wish to teach

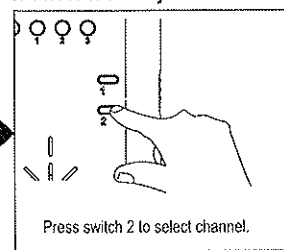

4. Teach transmitter code

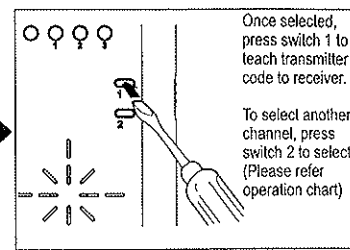

5. Verification

* After teaching all the transmitter codes (if you have multiple transmitters), return the receiver to normal operation status.
* Make sure that the receiver operates correctly with all the repeaters and the transmitters.

Note: Make sure to teach TR-20U's code to the receiver after teaching transmitter code to the repeater.

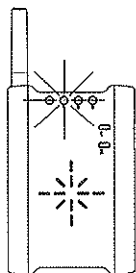

OPERATION CHART for teaching TR-20U's code to the receiver.

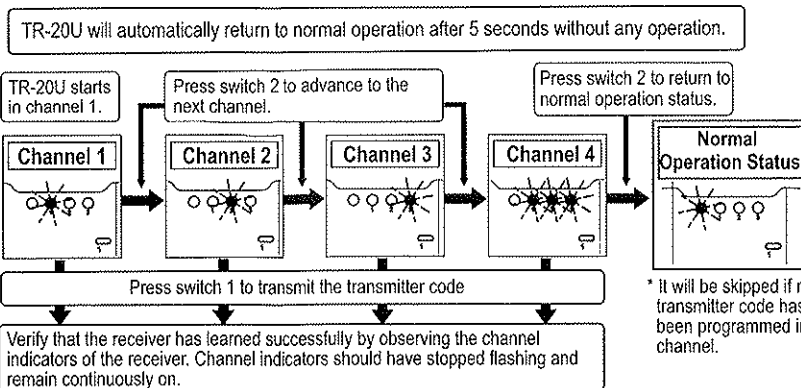

⑧ TROUBLESHOOTING

1. The system is not operating

Check the transmitter.

- Does the status indicator light up when you trigger the transmitter? → Check to see whether the battery is inserted correctly. If the battery is old, replace it with a new one.
- Is the status indicator of the transmitter flashing? → The battery is old. Replace the battery.

Check the receiver.

- Is the power indicator of the receiver lit? → Is the receiver on? Check the wiring and connection.
- Have all the transmitter codes had been taught correctly? → Teach the transmitter codes correctly. The system will not operate without this process.
- Is the volume setting correct? → Is the volume set to "0"? If so, readjust the volume.
- Are there other high power appliances using the same electrical power outlet? → Please connect the receiver to a different electrical outlet.
- The zone indicator of the receiver is on, but nothing happens. → Check to see whether the terminal is properly connected to other devices.
- Is there anything blocking the transmission? → Relocate the receiver and/or the transmitter. Metal objects can shorten the effective transmission range.
- Are the zone indicators flashing slowly? → Follow directions in ⑨ LOW BATTERY INDICATION of the receiver's manual.

Check the repeater.

- Is the power indicator of the TR-20U lit? → Is the TR-20U on? Check the wiring and connection.
- Have all the transmitter codes had been taught correctly? → Teach the transmitter codes correctly. The system will not operate without this process.
- Are there other high power appliances using the same electrical power outlet? → Please connect the receiver to a different electrical outlet.
- Is there anything blocking the transmission? → Relocate the TR-20U and/or the transmitter. Metal objects can shorten the effective transmission range.
- Are the channel indicators flashing slowly? → Follow directions in ⑨ LOW BATTERY INDICATION.

2. The system is not operating correctly.

- The TR-20U does not learn the transmitter codes. → Check whether the transmitter codes have already been "learned" in a different channel. If so, erase the memory and teach again.
- The TR-20U gets reception in the wrong channel. → Erase memory in the channel in which the RC-20U responds and teach using the correct channel.
- A certain zone seem to malfunction. → This is probably the transmitter's problem. Check the transmitter that corresponds to that channel.
- Before contacting the supplier! → Go through the setups again after turning on the power while holding down switch 1.

* If the above solutions do not work, please contact your supplier for services.

⑨ COMPLIANCE

FCC ID : DC9TR-10U

The changes or modifications not expressly approved by the OPTEX could void the user's authority to operate the equipment. To comply with the FCC RF exposure compliance requirements, this device and its antenna must not be co-located or operating in conjunction with any other antenna or transmitter. Note: This equipment has been tested and found to comply with the limits for a Class B Digital Device, pursuant to part 15 of the FCC Rules. These limits are designed to provide reasonable protection against harmful interference in a residential installation. This equipment generates, uses and can radiate radio frequency energy and, if not installed and used in accordance with the instruction, may cause harmful interference to radio communication. However, there is no guarantee that interference will not occur in a particular installation. If this equipment does cause harmful interference to radio or television reception, which can be determined by turning the equipment off and on, the user is encouraged to try to correct the interference by one or more of the following measures: (1) Reorient or relocate the receiving antenna. (2) Increase the separation between the equipment and receiver. (3) Connect the equipment into an outlet on a circuit different from that to which the receiver is connected. (4) Consult the dealer or an experienced radio/TV technician for help.

IC : 4012A-000000TR20U

⑩ LOW BATTERY INDICATION

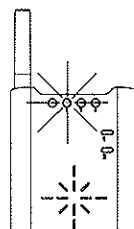

Channel indicator start slow flashing whenever the corresponding transmitters have low battery. Any operation cannot be done until one of operations below are conducted.

- 1) Replace transmitter's batteries.
- 2) Press switch 2.

TR-20U will not need to relearn transmitter after replacing the batteries.

⑪ SPECIFICATION

Model	TR-20U
Description	Repeater
Power Source	9VDC (Exclusive AC Adaptor)
Power Consumption	3W Max. (Including AC Adaptor 120V, 60Hz)
Status Indicator	Power Indicator: Green Channel Indicator: Red x 3
Frequency	418MHz
Operating Temperature	15°F ~ 120°F (-10°C ~ +50°C)
Installation Location	Indoor
Weight	6.0 oz (170g)
Accessories	Mounting Screw x 1 AC Adaptor x 1

Specifications may change without notice.

⑫ DIMENSIONS

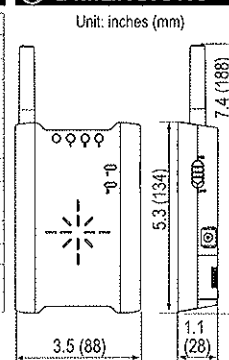

⑬ WARRANTY

1. This product is warranted under normal use for 1 year from the date of purchase. If the product proves to be defective, return it with a copy of your dated sales receipt for repairs or replacement without charge.
2. The warranty is not applicable when below circumstances will be found:
 - Mechanical or electrical modification(s) are made to the product or it is otherwise altered manually.
 - The product is already been serviced at place(s) other than the manufacturer.
 - It is determined that the product malfunction has resulted from improper use or from an accident.
 - No copy of the dated sales receipt has been submitted together with the product to be serviced.



OPTEX CO., LTD.
(ISO 9001 Certified)
(ISO14001 Certified)
5-8-12 Ogino, Otsu, Shiga, 520-0101 Japan
TEL : +81(0)72 570-8670

OPTEX INCORPORATED (USA)
13661 Banson Ave., Bldg. C, Chino, CA 91710 U.S.A.
TEL : +1-909-966-793
FAX : +1-909-628-5560
E-MAIL : us-909-966-5776