

WARNINGS AND CAUTIONS:

- **TO AVOID FIRE, SHOCK, OR DEATH; TURN OFF POWER AT CIRCUIT BREAKER OR FUSE AND TEST THAT THE POWER IS OFF BEFORE WIRING!**
- To be installed and/or used in accordance with electrical codes and regulations.
- To avoid overheating and possible damage to this device and other equipment, **DO NOT** install to control a receptacle.
- **DO NOT** control a load in excess of specified ratings or you may damage property, or cause injury or death.

WARNINGS AND CAUTIONS:

- If you are not sure about any part of these instructions, consult an electrician.
- Clean outer surface gently with damp cloth only. **DO NOT** use soaps or cleaning liquids.
- No user serviceable components. **DO NOT** attempt to service or repair.
- Use this device **WITH COPPER OR COPPER CLAD WIRE ONLY.**

Tools needed to install your Device

- Slotted/Phillips Screwdriver Electrical Tape Pliers
Pencil Cutters Ruler

Changing the color of your device

Your device may include color options. To change color of the face proceed as follows:

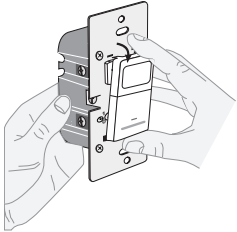

Push down tabs per diagram, one at a time and rotate forward to release

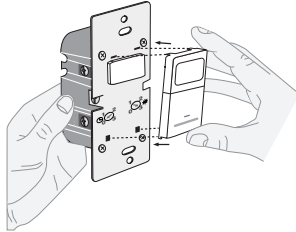

Attach new face by inserting bottom hinge tabs, then pivot and snap the color kit to attach

FEATURES

- Cat. No. IPS05 and IPV05 have a sensing area of coverage of 30 ft. x 30 ft., and a sensing angle of 180° (see Sensing Area Coverage figure on page 2)
- Adjustable light and time-delay controls are located on the front of the device. See adjustment setting section on page 2 for details.
- LED indicator is used to alert the user of the status of the device.
- Adjustable Time Delay setting for 30 seconds, 5 minutes, 15 minutes and 30 minutes.

LOCATION / MOUNTING

The device responds to temperature changes and care should be taken when mounting the device. **DO NOT** mount directly above a heat source, in a location where hot or cold drafts will blow directly on the sensor, or where unintended motion (e.g., hallway traffic) will be within sensor's field-of-view.

INSTALLING YOUR DEVICE

NOTE: Use check boxes when Steps are completed.

Step 1



WARNING: TO AVOID FIRE, SHOCK, OR DEATH; TURN OFF POWER at circuit breaker or fuse and test that power is off before wiring!

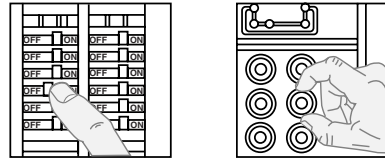

Step 2



Identifying your wiring application (most common):

NOTE: If the wiring in the wall box does not resemble any of these configurations, consult an electrician.

Single-Pole

1. Line (Hot)
2. Neutral
3. Ground
4. Load

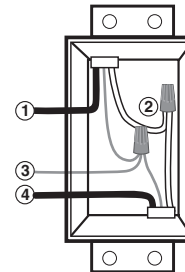

Step 3



Preparing and connecting wires:

This device can be wired using side wire terminal screws. Choose appropriate wire stripping specifications accordingly.

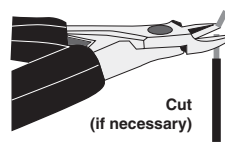

Cut (if necessary)

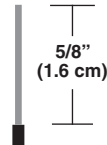

5/8" (1.6 cm)

Strip Gage (measure bare wire here or use gage on back of the sensor)

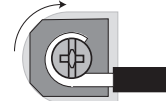

Side Wire Connection

Side wire terminals accept #14-12 AWG solid copper wire only.



Back Wire

Back wire openings use #14-12 AWG solid copper wire only.

- Make sure that the ends of the wires from the wall box are **straight (cut if necessary)**.
- Remove insulation from each wire in the wall box as shown.

Step 4



Single Pole Wiring Application:

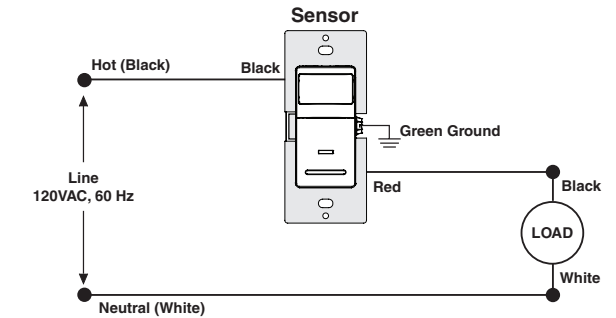
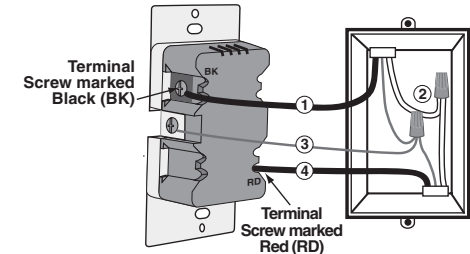

WIRING SENSOR:

Connect wires per WIRING DIAGRAM as follows:

NOTE: A ground connection is required to operate. Use the ground wire in the electrical box for ground connection. If there is no ground wire, make sure the electrical box is grounded and attach the ground wire to the box with a screw.

- Green or bare copper wire in wall box to Green terminal screw.
- Line Hot wall box wire to terminal screw marked "BK".
- Load wall box wire to terminal screw marked "RD".
- **Proceed to Step 5.**

Step 5 Testing your Device prior to mounting in wall box:

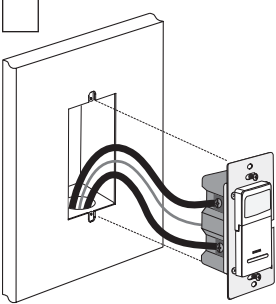

NOTE: Dress wires with a bend as shown in diagram in order to relieve stress when mounting device.

- Position all wires to provide room in outlet wall box for device.
- Ensure that the word "TOP" is facing up on device strap.
- Partially screw in mounting screws in wall box mounting holes.

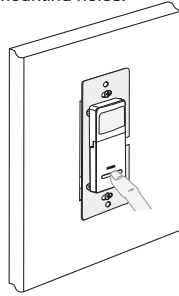

- Restore power at circuit breaker or fuse.
- Wait 20 seconds for sensor to power up.
- For IPS05, lights will automatically turn ON after power is applied.
- For IPV05, press push pad. Lights should turn ON.

If lights still do not turn ON, refer to the TROUBLESHOOTING section.

Step 6 Device Mounting: TURN OFF POWER AT CIRCUIT BREAKER OR FUSE.



Installation may now be completed by tightening mounting screws into wall box. Attach wallplate.

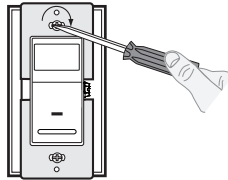

Step 7 Restore Power: Restore power at circuit breaker or fuse. Installation is complete.



OPERATION

IPS05

Auto On: Lights will automatically turn ON when room is occupied or motion is detected. The IPS05 will switch lights OFF when no motion is detected in un-occupied room after set period of time.

Time delay adjustment: Refer to section on Adjustment settings.

The IPS05 will manually turn-on lights or the load by depressing the ON/OFF paddle on the device. The IPS05 can be set to only turn ON by the pushpad (no automatic ON operation) by adjusting the ambient light control to the "0" position.

IPV05

Manual On: The IPV05 requires the user to manually turn-on lights or the load by depressing the ON/OFF paddle on the device. The lights or load will automatically turn-off when the room is left un-occupied for a set period of time.

Time delay adjustment: Refer to section on Adjustment settings.

Locator Light LED:

LED blinks once every 2 seconds when motion is detected and if the load is ON or OFF.

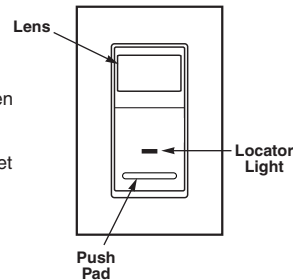

ADJUSTMENT SETTINGS

1. With power restored and wallplate removed, remove face of device to expose setting controls, see color change instructions in page 1. Use your finger or a small screwdriver to adjust the light sensitivity and time settings on the device as follows:

Light Level Adjustment:

- Turn the control clockwise. Lights will turn ON in lighter conditions.
- Turn the control counter clockwise. Lights will turn ON in less lighting conditions.

Time Selection:

- Adjust the time selector to the desired length of time the lights are to remain ON. Lights will remain ON from 30 seconds to 30 minutes after the room is vacated.
- Turn the control clockwise. Lights will remain ON up to 30 minutes.
- Turn the control counter clockwise. Lights will remain ON up to 30 seconds.

2. Test that the light level and time selection are as desired. If not, repeat adjustments until satisfied.
3. Mount wallplate. **INSTALLATION IS COMPLETE.**



Time Selection



Light Level Adjustment

Settings	Time
0	30 Sec
1	5 Min
2	15 Min
3	30 Min

SENSING AREA COVERAGE

Field-of-View (Horizontal)

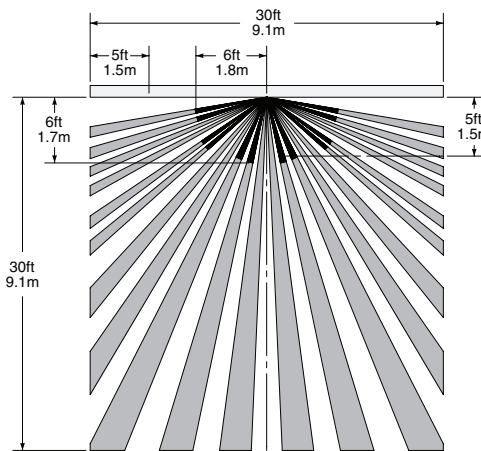

Side (Vertical) Field-of-View

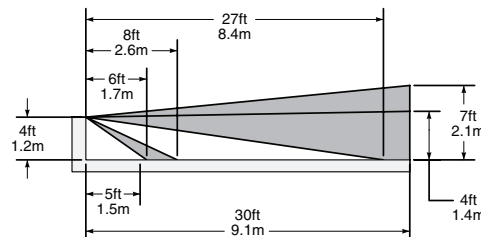

TROUBLESHOOTING

Lights do not operate with push pad and LED indicator does not blink when motion is present:

- Ensure proper ground connection is present in the wallbox. When confirmed, verify wiring connections to sensor.

Lights do not switch ON when motion is detected (IPS05):

- Motion is beyond sensing range, move closer to switch.
- Adjust the light level adjustment toward lighter (counterclockwise), depending on room conditions.

Lights always stay ON:

- Check time delay settings and compare to how long the lights stay ON.
- Ensure that no motion occurs in coverage area for time selected.
- Check that switch is not installed near a heat source (e.g., stove, lights, heat vents) or detecting motion from an adjacent area (e.g., hallway traffic). If so, switch may have to be relocated.

Lights do not turn ON - IPV05:

- Check that control is installed correctly.
- Check that power is ON.
- Check that light bulb is functioning.

NOTE: If problems continue, consult an electrician.

For additional information, contact Leviton's Techline at 1-800-824-3005 or visit Leviton's website at www.leviton.com

This product is covered by U.S. Pat. No. 7,924,155 & corresponding foreign patents.
© 2012 Leviton Manufacturing Co., Inc.
All Rights Including Trade Dress Rights Reserved

FCC COMPLIANCE STATEMENT

This device complies with Part 15 of the FCC Rules. Operation is subject to following two conditions: (1) this device may not cause harmful interference, and (2) this device must accept any interference received, including interference that may cause undesired operation of the device.

This equipment has been tested and found to comply with the limits for a Class B Digital Device, pursuant to Part 15 of the FCC Rules. These limits are designed to provide reasonable protection against harmful interference in a residential installation. This equipment generates, uses, and can radiate radio frequency energy and, if not installed and used in accordance with the instructions, may cause harmful interference to radio communications. However, there is no guarantee that interference will not occur in a particular installation. If this equipment does cause harmful interference to radio or television reception, which can be determined by turning the equipment OFF and ON, the user is encouraged to try to correct the interference by one or more of the following measures:

- Reorient or relocate the receiving Antenna.
- Increase the separation between the equipment and the receiver.
- Connect the equipment into an outlet on a circuit different from that to which the receiver is connected.
- Consult the dealer or an experienced radio/tv technician for help.

FCC CAUTION

Any changes or modifications not expressly approved by Leviton Manufacturing Co., Inc., could void the user's authority to operate the equipment.

LIMITED 5 YEAR WARRANTY AND EXCLUSIONS

Leviton warrants to the original consumer purchaser and not for the benefit of anyone else that this product at the time of its sale by Leviton is free of defects in materials and workmanship under normal and proper use for five years from the purchase date. Leviton's only obligation is to correct such defects by repair or replacement, at its option, if within such five year period the product is returned prepaid, with proof of purchase date, and a description of the problem to **Leviton Manufacturing Co., Inc., Attn: Quality Assurance Department, 201 North Service Road, Melville, New York 11747.** This warranty excludes and there is disclaimed liability for labor for removal of this product or reinstallation. This warranty is void if this product is installed improperly or in an improper environment, overloaded, misused, opened, abused, or altered in any manner, or is not used under normal operating conditions or not in accordance with any labels or instructions. **There are no other or implied warranties of any kind, including merchantability and fitness for a particular purpose,** but if any implied warranty is required by the applicable jurisdiction, the duration of any such implied warranty, including merchantability and fitness for a particular purpose, is limited to five years. **Leviton is not liable for incidental, indirect, special, or consequential damages, including without limitation, damage to, or loss of use of, any equipment, lost sales or profits or delay or failure to perform this warranty obligation.** The remedies provided herein are the exclusive remedies under this warranty, whether based on contract, tort or otherwise.