

Getting Started Guide

ANYWHERE SWITCH COMPANION Wire-free multi-location control

Easy Wi-Fi lighting control for the whole home



See the complete line of My Leviton™ app compatible dimmers, switches, plug-ins, and controllers at leviton.com/decorasmart

Cat. No. DAWSC

1

Welcome



The Decora Smart Anywhere Switch Companion pairs directly with any Decora Smart Wi-Fi 2nd Generation device to provide additional control wherever you need it. Mount it directly on your wall surface or at an existing wall box—no wiring required.

The Anywhere Switch Companion looks right at home with your other Decora Smart Wi-Fi devices and features familiar on/off controls.

Anywhere Companion devices do not require Wi-Fi or an app for setup.

We are here to help

- ONLINE**
decorasmartsupport.leviton.com
- EMAIL**
dssupport@leviton.com
- CHAT**
www.leviton.com/contact
- CALL**
1-800-824-3005 (USA)
1-800-405-5320 (Canada)

2

Ease of use

- Pair the Anywhere Switch Companion with a Decora Smart Wi-Fi 2nd Gen Dimmer or Switch for additional on/off control where you need it most like at the base of a staircase or end of a hallway.



- Pair the Anywhere Switch Companion with a Decora Smart Wi-Fi 2nd Gen Mini Plug-In to add on/off control of connected lamps or appliances to any indoor wall surface.

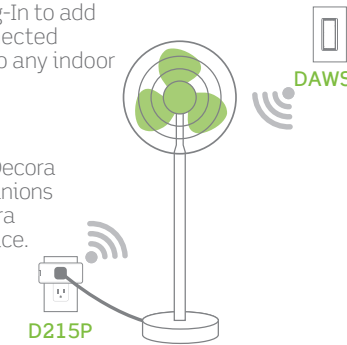

3

Quick tip: Up to three Decora Smart Anywhere Companions can be paired to a Decora Smart Wi-Fi 2nd Gen device.

Features

- Place it **anywhere** you need additional lighting control:
 - Create 3-way/multi-way control with no wiring.
 - Mount directly to your wall surface or install at an existing wall box where a traveler wire may not be present.
- Classic Decora style.
- No Wi-Fi or app required for setup.
- Fits Leviton Decora standard and screwless wallplates (single and multi-gang).
- 5 year battery life. Replaceable CR2025 batteries included.
- Pair up to three Anywhere Companions with a Decora Smart Wi-Fi 2nd Gen device.

For more information and features visit: leviton.com/decorasmart

4

If you need help...

- ONLINE**
decorasmartsupport.leviton.com
- CHAT**
www.leviton.com/contact
- EMAIL**
dssupport@leviton.com
- CALL**
1-800-824-3005 (USA)
1-800-405-5320 (Canada)

At a glance

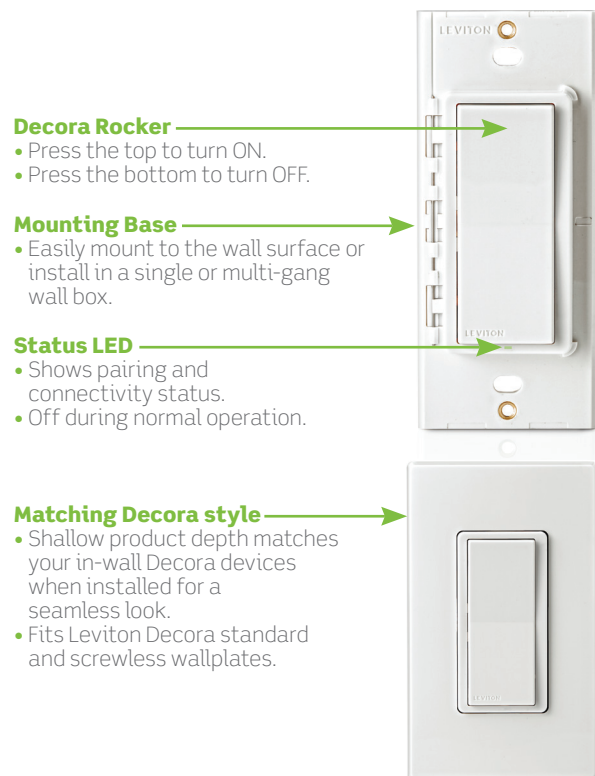

- Decora Rocker**
- Press the top to turn ON.
 - Press the bottom to turn OFF.

- Mounting Base**
- Easily mount to the wall surface or install in a single or multi-gang wall box.

- Status LED**
- Shows pairing and connectivity status.
 - Off during normal operation.

- Matching Decora style**
- Shallow product depth matches your in-wall Decora devices when installed for a seamless look.
 - Fits Leviton Decora standard and screwless wallplates.

5

Your Anywhere Switch Companion works with:

- Decora Smart Wi-Fi 2nd Generation devices:



- Visit Leviton.com/decorasmart for product compatibility updates.

- NOTES:**
- Anywhere Companion devices are battery powered and pair with Wi-Fi 2nd Generation devices using wireless RF technology for reliable communication.
 - Anywhere Companions do not connect directly to the load/lights. A line powered primary Wi-Fi 2nd Gen Device or Mini Plug-in is required (sold separately).
 - Anywhere Switch Companions are for ON/OFF control only.
 - Do not use with metal wallplates.
 - For indoor use only.

SPECIFICATIONS	
Operating Temp	0°C - 40°C (32°F - 104°F)
Operating Humidity	0 - 90% non-condensing
Storage Temperature Range	-10°C - 85°C
Batteries	CR2025 (2)
Network	2.4GHz
Range	50 ft.

6

Installation

Mounting on a wall surface:

1. Select a clear wall surface within a 50 ft. range of the primary Decora Smart Wi-Fi 2nd Gen device.
2. Place included adhesive tape on the reverse side of the Anywhere Companion; align the top and bottom pieces of tape with the corner markings molded into the base.

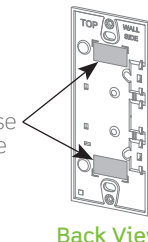

3. Take note of the TOP and WALL SIDE markings on the back of the device and gently affix the Anywhere Companion to the wall surface using the adhesive tape. Make sure the device is securely held in place and level.

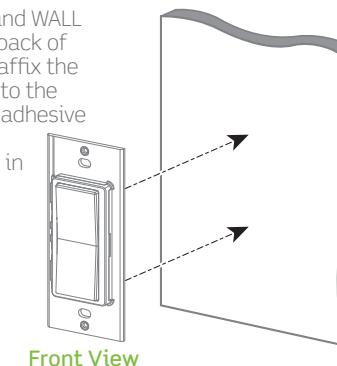

If at any time you are unsure about the installation process, contact Leviton technical support or consult an electrician.

7

Installation

WARNING: TO AVOID FIRE, SHOCK OR DEATH, turn off power at the circuit breaker.

Installing at the wall box:
To install in a standard NEMA electrical box in single-gang or multi-gang installations:

1. Take note of the TOP marking on the reverse side of the Anywhere Companion.
2. Turn off power at the circuit breaker during installation. Line up the Anywhere Companion with the screw holes in the desired location at the wall box. Make sure the location is within a 50 ft. range of the primary Decora Smart Wi-Fi 2nd Gen device.

3. Screw in the Anywhere Companion to the wall box via the innermost screw holes using the included wall box screws. Tighten the screws until snug. Do not overtighten screws.

NOTE: Installation in a metal wall box can weaken the RF signal and reduce wireless range.

If at any time you are unsure about the installation process, contact Leviton technical support or consult an electrician.

8

Powering up

The Anywhere Companion comes with two CR2025 batteries already installed.

1. To power up the Anywhere Companion, place your finger on the indent in the base.

2. Open the device by rotating the frame gently to the left using the hinge.

3. Grasp each pull tab by the circular portion and pull up to remove. Remove both pull tabs (each battery). This will activate power and put the Anywhere Companion into Pairing Mode. **The Status LED will begin flashing GREEN.**

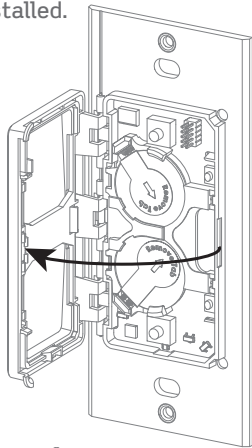

9

Powering up (continued)

4. Close the device by rotating the frame gently to the right using the hinge.

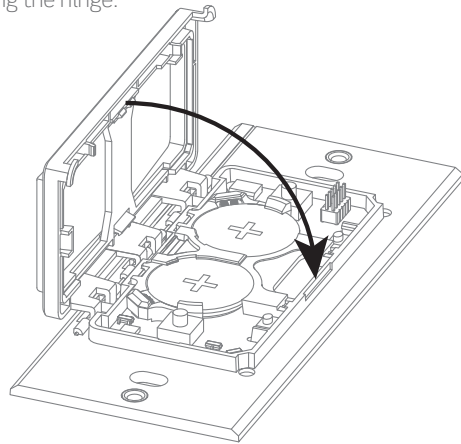

10

5. Press down firmly in the corners until the device snaps closed.

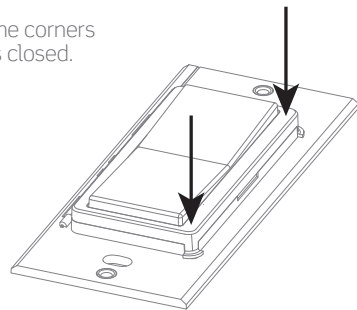

Pairing

Follow the below steps to pair the Anywhere Companion with its primary Decora Smart Wi-Fi 2nd Gen device.

Activate and pair one Anywhere Companion at a time.

1. Make sure the Anywhere Companion is in pairing mode and its Status LED is blinking green.

NOTE: If not paired after 10 minutes, the Anywhere Companion will enter a standby state to preserve battery life. To place it back into pairing mode, single press the top rocker 5 times. The Status LED will begin flashing GREEN.

2. Place the primary Decora Smart Wi-Fi 2nd Gen Device into Pairing Mode:

- For in-wall devices press the top rocker 5 times.
- For plug-in devices press the control button 5 times.
- The Status LED will flash green/amber when in pairing mode.

3. The Decora Smart Wi-Fi 2nd Gen device will automatically pair to the Anywhere Companion in pairing mode in wireless RF range. Once paired, the Anywhere Companion's Status LED will briefly turn solid GREEN to show a successful connection.

NOTE: The primary Decora Smart Wi-Fi 2nd Gen device pairs one Anywhere Companion at a time. To pair up to three Anywhere Companions, place the primary Decora Smart Wi-Fi 2nd Gen device back into Pairing Mode and restart the process with the next Anywhere Companion.

11

Test control

Once the Anywhere Companion device has been installed and successfully paired to its primary Decora Smart Wi-Fi 2nd Gen device, test control by pressing the Anywhere Companion's rocker ON and OFF to toggle the load.

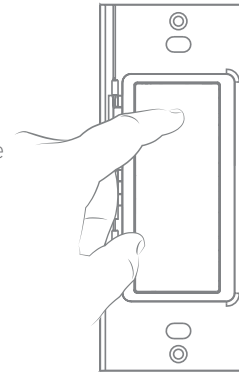

Attach the wallplate

1. Attach the screwless wallplate mounting bracket by screwing into the outermost screw holes. Tighten screws until snug—do not overtighten.

2. Snap on the Decora screwless wallplate.

NOTE: Anywhere Companions are compatible with Leviton Decora standard and screwless wallplates in single and multi gang configurations.

Congratulations! You have successfully setup your Anywhere Switch Companion!

12

Changing the batteries

1. Remove the wallplate (if using a screwless wallplate, the mounting bracket does not need to be removed).

2. Find the indent in the base and use your finger to open the device by rotating the frame gently to the left using the hinge.

3. Place finger in gap as marked by arrows.

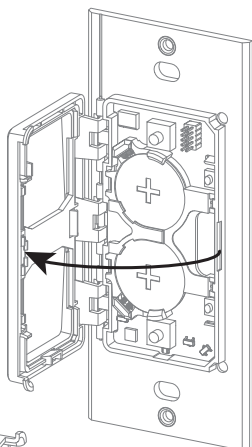

13

Changing the batteries (continued)

4. Gently lift batteries out of holder. While lifting batteries, press out on battery holder tabs as needed to release batteries.

5. Replace with CR2025 batteries only.

6. Close the device by rotating the frame gently to the right using the hinge.

7. Press down firmly in the corners until the device snaps closed.

8. Snap on the wallplate.

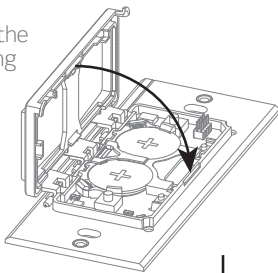
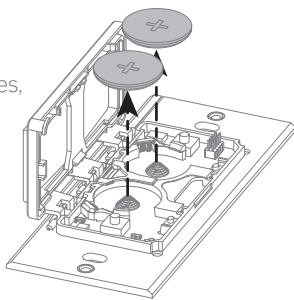

14

If at any time you are unsure or need help contact Leviton support or visit leviton.com/decorasmart

Status LED

COLOR	ACTIVITY	STATUS
Not lit	N/A	Normal Operation.
Green	Solid	Button has been pressed (normal feedback) or device pairing confirmation.
Green	Fast Blink	Device is in Pairing Mode.
Amber	Slow Blink	Device has lost connection to its primary Decora Smart Wi-Fi 2nd Gen Device.
Red	Slow Blink	Low battery warning.

Diagnostic LED

If the Anywhere Companion is not functioning as expected the Status LED can be used as a diagnostic tool. Press the top rocker for at least 2 seconds but less than 7 seconds, then release. The device should blink a diagnostic code for two seconds.

COLOR	STATUS
Green	Normal operation; connected to a primary device.
Amber	Not connected to a primary device.
Red	Low battery warning.

15

What to do if...

If your Anywhere Companion is not performing as expected, visit leviton.com/decorasmart or contact Leviton's technical services team.

The Anywhere Companion will not pair to the primary Decora Smart Wi-Fi device:

- Make sure you are pairing to a Decora Smart Wi-Fi 2nd Gen device and that both the Anywhere Companion and primary are in range and in pairing mode.

How do I know if I have a primary Decora Smart Wi-Fi 2nd Gen device?

- Make sure your 5 digit part number starts with D2. To locate the part number: For an in-wall device, remove the wall plate and find the 5 digit part number in the upper right hand corner of the strap. For a plug-in, the 5 digit part number is on the reverse side of the device.

The Anywhere Companion has an intermittent connection to its primary Decora Smart Wi-Fi 2nd Gen device:

- Make sure the Anywhere Companion is within a 50 ft. range of the primary device.
- This product is not designed to transmit through exterior surfaces. Environmental factors can impact wireless range. Before installing, consider materials such as concrete or steel reinforced floors, ceilings, walls, masonry, cinderblock, and reinforced materials such as plaster and stucco that may interfere with range.
- Check to make sure you do not have a low battery; see page 15 for how to check the battery level using the Diagnostic LED.

Can I control multiple Decora Smart Wi-Fi 2nd gen devices with a single Anywhere Companion?

- No, however up to three Anywhere Companions can be paired to a Decora Smart Wi-Fi 2nd Gen device.

How do I clean my device?

- To clean use a damp cloth with mild soap. **DO NOT** use disinfecting products, including foggers, sprays or other types of atomized cleaning agents.

Additional self-help resources can be found at leviton.com/decorasmart

16

Factory default reset

1. Hold the top of the Decora Rocker for 14 seconds.
2. After the first 7 seconds the status light will turn AMBER. Continue to hold.
3. After 7 more seconds, the status light will quickly flash RED/AMBER.
4. Release the top of the Decora Rocker and the device will reset. This will remove all pairing associations.

Safety first

WARNINGS:

- This product is to be installed and/or used in accordance with electrical codes and regulations.
- For indoor use only.
- If you are unsure about any part of these instructions, consult an electrician.

CAUTIONS:

- Save this instruction sheet. It contains important technical data along with testing and troubleshooting information which will be useful after installation is complete.
- Leviton Decora Smart Anywhere Companions rely on wireless RF communication.
- Decora Smart Anywhere Companion devices use 2 CR2025 coin cell batteries ONLY. Do not use a rechargeable battery. Use of an improper battery may cause damage to the device.

Limited 2 Year Warranty & Exclusions

For Leviton's limited product warranty, go to www.leviton.com. For a printed copy of the warranty, call 1-800-824-3005.

FOR CANADA ONLY

For warranty information and/or product returns, residents of Canada should contact Leviton in writing at Leviton Manufacturing of Canada ULC to the attention of the Quality Assurance Department, 165 Hymus Blvd, Pointe-Claire (Quebec), Canada H9R 1E9 or by telephone at 1 800-405-5320.

FCC COMPLIANCE STATEMENT

The enclosed device complies with Part 15 of the FCC Rules. Operation is subject to the following two conditions: (1) This device may not cause harmful interference (ii) This device must accept any interference received, including interference that may cause undesired operation. Any changes or modifications not expressly approved by Leviton could void the user's authority to operate this equipment. This equipment has been tested and found to comply with the limits for a Class B digital device, pursuant to part 15 of the FCC Rules. These limits are designed to provide reasonable protection against harmful interference in a residential installation. This equipment generates uses and can radiate radio frequency energy and, if not installed and used in accordance with the instructions, may cause harmful interference to radio communications. However, there is no guarantee that interference will not occur in a particular installation. If this equipment does cause harmful interference to radio or television reception, which can be determined by turning the equipment off and on, the user is encouraged to try to correct the interference by one or more of the following measures:

- Reorient or relocate the receiving antenna.
- Increase the separation between the equipment and receiver.
- Connect the equipment into an outlet on a circuit different from that to which the receiver is connected.
- Consult the dealer or an experienced radio/TV technician for help.

FCC CAUTION

Any changes or modifications not expressly approved by Leviton Manufacturing Co., Inc., could void the user's authority to operate the equipment.

FCC SUPPLIER'S DECLARATION OF CONFORMITY

Model DAWSC - Anywhere Switch Companion is manufactured by Leviton Manufacturing Co., Inc. 201 N. Service Road, Melville, NY 11747. www.leviton.com This device complies with part 15 of the FCC Rules. Operation is subject to the following two conditions: (1) This device may not cause harmful interference, and (2) this device must accept any interference received, including interference that may cause undesired operation.

IC STATEMENT

This device complies with Industry Canada license-exempt RSS standard(s). Operation is subject to the following two conditions: (1) this device may not cause interference, and (2) this device must accept any interference, including interference that may cause undesired operation of the device.

RF EXPOSURE AND CO-LOCATION

To comply with FCC OET Bulletin 65 and ICSED RF exposure limits for general population and uncontrolled exposure, this device shall be installed and operated with a minimum distance of 79 inches (20 cm) between the radiator and your body. Also, must not be co-located or operated in conjunction with any other antenna or transmitter.

Copyright and Trademark Information

Decora and Decora Smart are the registered trademarks of Leviton Manufacturing Co., Inc., registered in the U.S., Canada, Mexico and China. Use herein of other third party trademarks, service marks, trade names, brand names and/or product names are for informational purposes only, are/may be the trademarks of their respective owners; such use is not meant to imply affiliation, sponsorship, or endorsement. No part of this document may be reproduced, transmitted or transcribed without the express written permission of Leviton Manufacturing Co., Inc. Copyright 2021 Leviton Mfg. Co., Inc.

WEBERSIC