

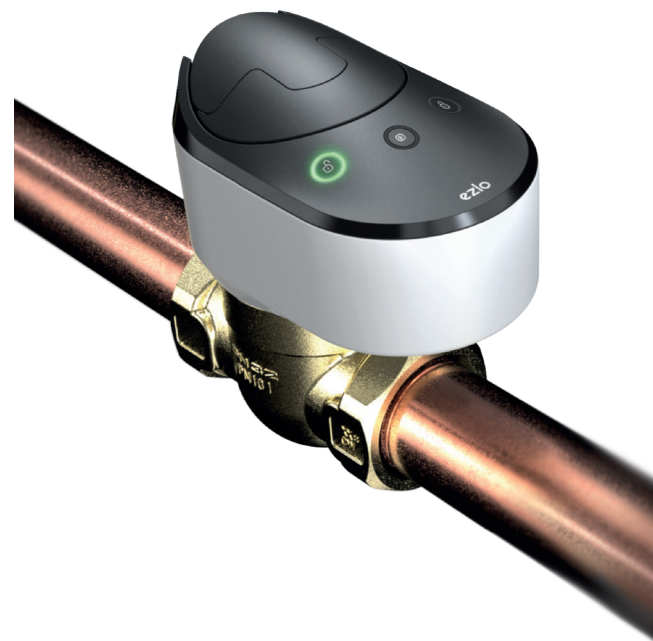

Smart Water Shut-Off Valve

Quick Start Guide



Water damage prevention and home control in a single device

Contents

- What's in the Box..... 2
- Smart Valve Basics 3
- Installing your App 4
- Adding your Hub 4
- Connecting the Actuator to the Ball Valve 5
- Setup..... 6
- Adding devices to the Smart Valve hub..... 7
- Regulatory Information..... 8

What's in the Box

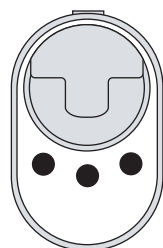

Actuator

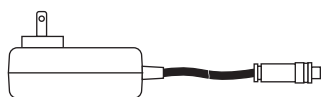

Power Adapter

What you'll need

- ¾", 1" or 1¼" Ezlo Ball Valve (sold separately)
- Home Wi-Fi Network
- iOS or Android Smart Phone or Tablet

Note: The ball valve is plumbed directly into your home's water main and may require professional installation. If you require assistance, please contact your local plumber before proceeding.

Smart Water Shut-Off Valve Basics

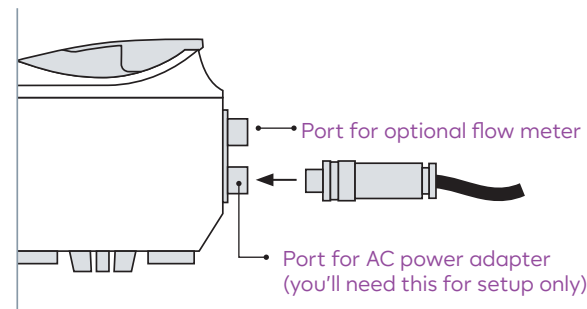
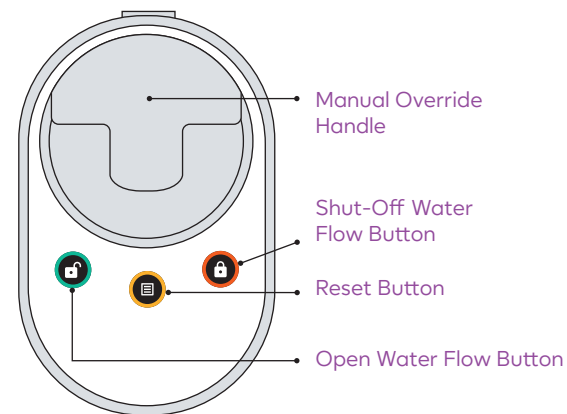

1. Installing your App

While you wait for the ball valve to be installed, let's set up the control hub functionality of your Smart Water Shut-Off Valve.

Visit ezlo.com/app on your iOS or Android phone or tablet to download the Vera Mobile app.

Create your account

Now it's time to create your Vera Mobile account. The app will walk you through it, and once you're done, the account will automatically be linked to your hub.

2. Adding your Hub

1. From the My Controllers list, tap Add New Controller and select the Water Valve.
2. Next, connect the A/C power adapter to the bottom port on the rear of your Smart Water Shut-Off Valve. Once it is powered on, the LED should blink orange.
3. Follow the prompts to connect the Smart Water Shut-Off Valve to your home Wi-Fi network.
4. Your Smart Water Shut-Off Valve is now connected and its LED will be a steady green when it's open, or steady red if the valve is closed.

Note: If your Smart Water Shut-Off Valve fails to connect to your Wi-Fi, the valve may be too far from your router. In this instance, you may need to use a range extender to enhance your Wi-Fi signal to the valve.

3. Connecting the Actuator to the Ball Valve

Once the ball valve has been plumbed into your home's water system, disconnect the Smart Water Shut-Off Valve from its AC power cable and snap it into the ball valve. Then reconnect it to a nearby power source.

If your Smart Water Shut-Off Valve is outside or plumbed away from a power source, you may need to use an extension cord.

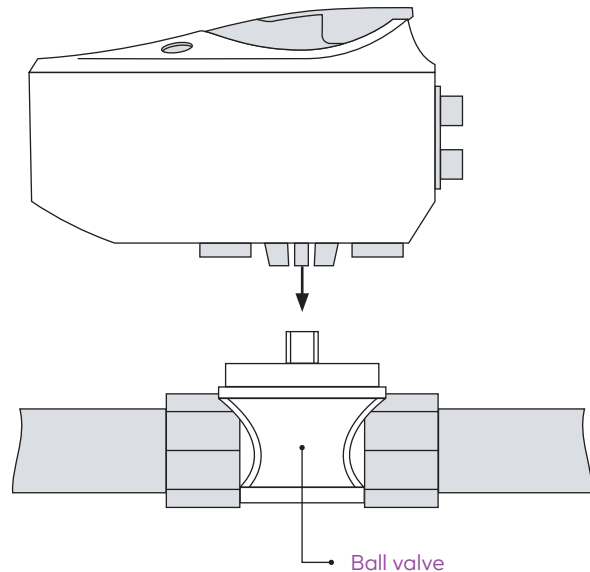

4. Setup

Using the app, find the **Water Valve** in the Devices section, then toggle the Valve closed and open.

For even more capabilities, try pairing your Smart Water Shut-Off Valve with a Z-Wave Water Leak Sensor, create a scene that will close the valve if water is detected, and then drip some water onto the sensor.

Note: If your Smart Water Shut-Off Valve is more than 30 feet from where your leak sensors will be placed, you may need to bring them within 10 feet of each other for pairing, and then add a Z-Wave range extender in order for them to communicate from a distance.

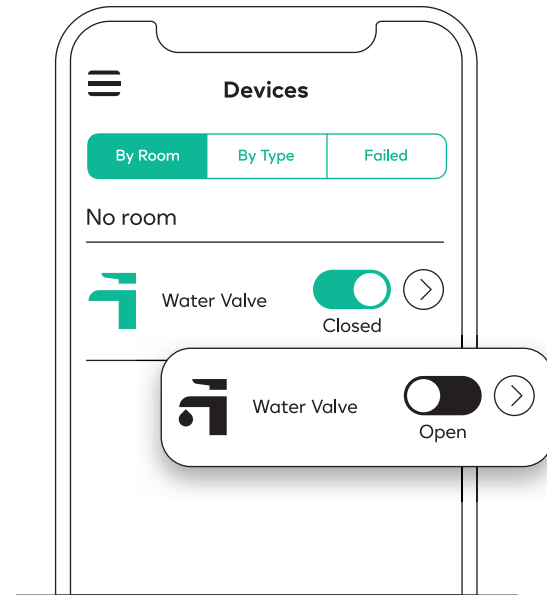

5. Adding devices to the Smart Water Shut-Off Valve

The Smart Water Shut-Off Valve's hub capabilities let you control multiple devices from a single app. When you add devices such as leak sensors, lights, thermostats, and more to your system, you'll be able to enjoy greater comfort and peace of mind with just a touch.

To add new devices, just tap the + sign from the Devices screen to launch the Device Pairing Wizard.

Control your home from anywhere.

The Vera Mobile app offers some key features that help you simplify things at home and help you keep an eye on things when you're away.

Modes

Modes give you the power to control all your devices with a single tap. There are pre-set modes for Home, Away, Night, and Vacation.

Scenes

The true power of home automation is when your home can do things for you. With Scenes, you can schedule your lights to turn off when you leave for work in the morning, or to fade up as day turns to night.

Notifications

Your Vera system can send push notifications or emails to let you—or other users—know about what's going on at home. Want to know when the front door opens? Or if motion is detected outside? You can set alerts for just about anything.

Regulatory Information

FCC Information:

This device complies with part 15 of the FCC Rules. Operation is subject to the following two conditions: (1) this device may not cause harmful interference, and (2) this device must accept any interference received, including interference that may cause undesired operation.

Note: This equipment has been tested and found to comply with the limits for a Class B digital device, pursuant to part 15 of the FCC Rules. These limits are designed to provide reasonable protection against harmful interference in a residential installation. This product generates, uses, and can radiate radio frequency energy and, if not installed and used in accordance with the instructions, may cause harmful interference to radio communications. However, there is no guarantee that interference will not occur in a particular installation. If this equipment does cause harmful interference to radio or television reception, which can be determined by turning the equipment off and on, the user is encouraged to try to correct the interference by one or more of the following measures:

Reorient or relocate the receiving antenna.

Increase the separation between the equipment and receiver.

Connect the equipment to an outlet on a circuit different from that to which the receiver is connected.

Consult the dealer or an experienced radio/TV technician for help.

Please take attention that changes or modification not expressly approved by Ezlo Innovation could void the user's authority to operate the equipment. This equipment should be installed and operated with a minimum distance 20cm between the radiator and your body.

Industry Canada ICES-003 Compliance

This device meets the CAN ICES-3 (B)/NMB-3(B) standards requirements.

This device complies with Industry Canada licence-exempt RSS standard(s). Operation is subject to the following two conditions: (1) this device may not cause interference, and (2) this device must accept any interference, including interference that may cause undesired operation of the device.

Under Industry Canada regulations, this radio transmitter may only operate using an antenna of a type and maximum (or lesser) gain approved for the transmitter by Industry Canada. To reduce potential radio interference to other users, the antenna type and its gain should be so chosen that the equivalent isotropically radiated power (e.i.r.p.) is not more than that necessary for successful communication.

This equipment complies with IC RSS-102 radiation exposure limits set forth for an uncontrolled environment. This equipment should be installed and operated with minimum distance 20cm between the radiator & your body.