

## OVERVIEW

The ELK-960 features adjustable delay time of one (1) second to approximately sixty (60) minutes. It can be operated by 12 to 24 volts D.C. and can be triggered by a negative (-) or positive (+) voltage. The operating mode and the relay condition can be set as follows: **BEGIN**- Relay turns on when triggered and back off when delay time expires. **END**- Relay turns off when triggered and back on when delay time expires. The delay time can start when the trigger is first applied (**B** mode) or when the trigger is removed (**A** mode). The ELK-960 relay can be set to provide a single **1-SHOT** output or to **REPEAT** (pulse on and off). All options are selected using easy to change mini-jumpers.

## TERMINAL DESCRIPTIONS

- +** Positive power input. Connect a +12 to +24 Volts D.C. source. **Warning: Do not exceed +24 Volts D.C., Damage will occur.**
- Negative power (ground) input. Connect to a negative or ground terminal of the power source.
- TGR** Trigger voltage input. Connect a 4.5 to 24VDC trigger source. Place jumper **JP5** (TRIGGER POLARITY) in the "+" position to trigger from a positive voltage or in the "-" position to trigger from a negative. The trigger voltage may be 4.5 to 24VDC, regardless of the main powered input (12Vdc to 24VDC).
- N/O** Normally Open side of the relay contacts. No connection to COM when the relay is off.
- COM** Common or "pole" side of the relay contacts. When the relay is off, COM is internally connected with the N/C contact. When the relay is on, COM is internally connected with the N/O contact.
- N/C** Normally Closed side of the relay contacts. This terminal is internally connected with the COM terminal when the relay is off.

**NOTE:** The ELK-960 automatically triggers (turns on) and runs through a delay cycle when first powered up. To reduce waiting time and speed up installation, set jumper JP1 to SECONDS and adjust R3 to 1 before applying power. Once power is applied, change the settings as required.

## SETTINGS AND JUMPER DESCRIPTIONS

**R3** This knob is used to increase or decrease the delay time from 1 to 60. Full clockwise is 1, halfway is 30, full counter-clockwise is 60. The arrow is a reference point.

**JP1** **SEC** = Delay time in seconds. Adjustable from 1 ~ 60.<sup>1</sup>  
**MIN** = Delay time in minutes. Adjustable from 1 ~ 60.<sup>1</sup>

**JP2** **REPEAT** = (Adjustable pulse) Relay cycles ON / OFF at delay time interval using a 50/50 duty cycle.<sup>2</sup>  
A trigger input will temporarily stop the cycle.  
**1-SHOT** = Relay activates only once per trigger.

**JP3** **END** = Relay turns off when triggered and back on when delay time expires.  
**BEGIN** = Relay turns on when triggered and back off when delay time expires.

**JP4** **A** = Delay time starts when trigger is removed.  
**B** = Delay time starts when trigger is first applied.

**JP5** **+** = Selects positive polarity for the input trigger.  
**-** = Selects negative polarity for the input trigger.

<sup>1</sup> Times are approximate. When adjusted to the highest setting (60 minutes) the actual time delay will be slightly greater.

**HINT:** For a delay time in minutes, adjust and test with jumper JP1 in the SECONDS position. (IE: For a 15 minute delay, adjust and test to 15 seconds) Then move jumper JP1 to MINUTES. This quickly provides a reasonable equivalent delay time in minutes.

<sup>2</sup> A 50/50 duty cycle means the OFF and ON times will be equal.

# Delay Timer ELK-960

## APPLICATION:

The **ELK-960** is an economical and flexible solution for many general-purpose time delay applications. The unit operates on 12 to 24 Volts D.C. and can be selected for positive or negative trigger logic. Setup is easy with thumbwheel adjustment between 1 and 60 seconds, a quick jumper setting converts the time from seconds to minutes. The timer can be configured to activate once for each trigger, or pulse as soon as power is applied.

**ELK**  
PRODUCTS, INC.

## Delay Timer ELK-960



Economical Time Delay Relay Module

## FEATURES:

- Operating Voltage Range: 12 to 24 Volts D.C.
- Adjustable Delay Time.
- Positive or Negative Low Current Trigger.
- **SPDT** (Form "C") Relay.
- Selectable Initial Relay State: ON / OFF.
- Output Modes: One-Shot or Repeat.
- LED Indication of Relay Status.
- Lifetime Limited Warranty, call for details.
- Packed In Reusable Poly Storage Box.

## SPECIFICATIONS:

- Time Settings: 1 Sec to ~ 60 Min.
- Relay Contact Rating: 7A @ 30 VDC.  
10A @ 125 VAC.
- Operating Voltage: 12 to 24 Volts D.C.
- Trigger Voltage: 4.5 - 24 Volts D.C.
- Input Trigger Current: 1.2 mA.
- Current Draw With Relay On: 40mA.
- Size: 3"x2.2"x1" (Fits Std. Snap Track).

Features and Specifications subject to change without notice.

**ELK**  
PRODUCTS, INC.

PO Box 100 • Hwy. 70W • Hildebran, NC 28637 • USA

828-397-4200 Voice  
828-397-4415 Fax  
<http://www.elkproducts.com>  
email: [info@elkproducts.com](mailto:info@elkproducts.com)

Instructions Printed On Inside

# SAMPLE APPLICATIONS AND WIRING DIAGRAMS (Set jumpers as shown)

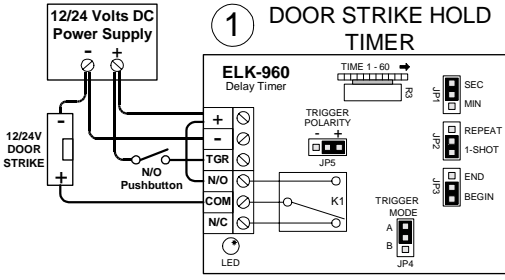

Used to extend the release time of an access control device or to manually activate a door **strike** release device. The trigger is activated by a contact closure or a N/O pushbutton and the door strike remains activated (door open) after the button is released for the delay time set up in the ELK-960.

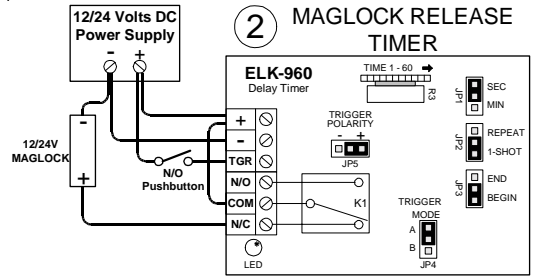

Used to extend the release time of an access control device or to manually activate a door **maglock** release device. The trigger is activated by a contact closure or a N/O pushbutton and the door maglock remains released (door open) after the button is released for the delay time set up in the ELK-960.

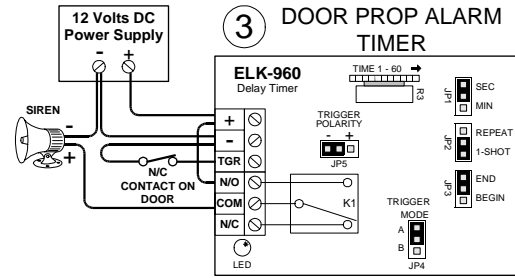

Delay is started when the door is opened. If the door remains opened after the time delay has expired the relay will turn on and remain on until the door is closed. If the door is closed before the time delay expires the ELK-960 is reset awaiting another input from the door contact.

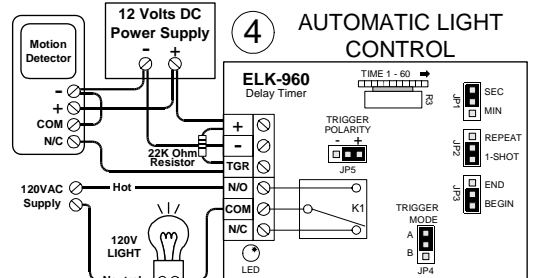

For turning on an interior or exterior light with a motion detector. When motion is detected, the ELK-960 is triggered and the light is turned on. The amount of time the light remains on after the detector resets is adjustable. Delay time will automatically restart each time the motion detector activates.

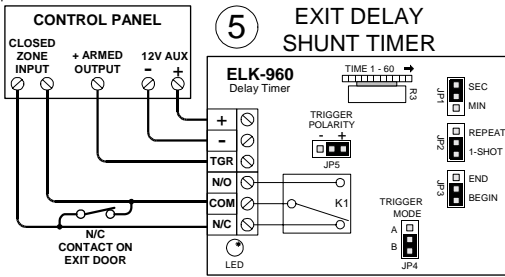

Provides an exit delay to an otherwise instant alarm loop. The ELK-960 is triggered by the control's Armed output. The door contact is then shunted by the relay contacts. After the user has exited and the delay time has expired, the door contact is restored into the loop.

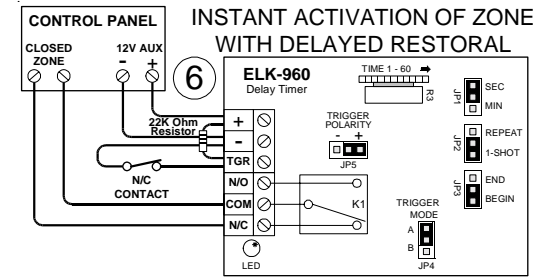

When contact opens, relay is turned on which causes instant zone violation. Contact closure will cancel trigger applied by resistor. Delay starts when contact closes. Relay turns off and zone restores after delay time expires.

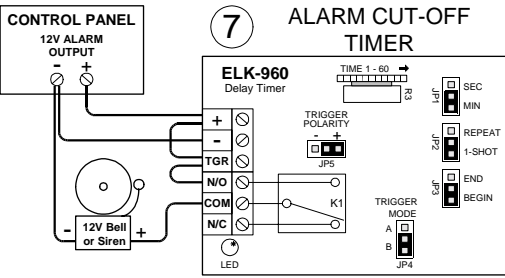

Useful for adding a cut-off timer to a control panel that does not have one. It can also be used to shorten the cut-off timer for a control with no adjustable timer.

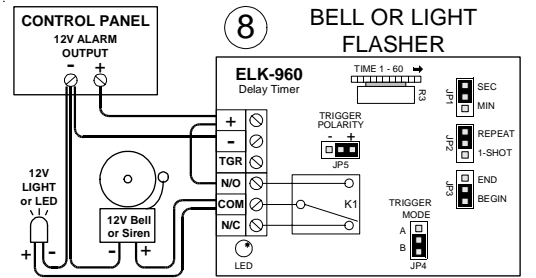

Converts a steady output to pulsing, suitable for flashing a light or pulsing an audible device. Note: Alarm output must be capable of supplying enough current to drive the bell and light.

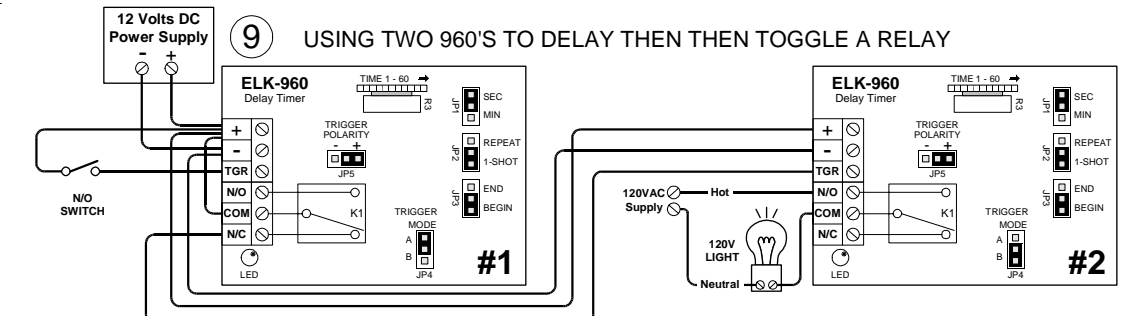

Used for delaying a trigger then toggling a relay on/off. ELK-960 #1 starts a time delay when the N/O switch is closed. When 960 #1's time delay expires, 960 #2 is triggered turning it's relay on for the time delay setting, then turning the relay off. (toggle) To summarize: fire trigger on #1, waits, turns on #2's relay, waits, then turns relay off.