

DXS-73

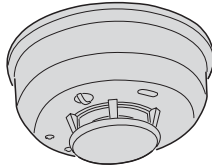

WIRELESS PHOTOELECTRIC SMOKE ALARM

Installation Instructions



(760) 438-7000
USA & Canada (800) 421-1587 & (800) 392-0123
Toll Free FAX (800) 466-1340
www.linearcorp.com

PRODUCT DESCRIPTION

The DXS-73 is a photoelectric smoke alarm with a built-in transmitter designed for use with Linear's DXS and DX Format receivers. When smoke is detected, the alarm sounds a loud local alarm. Twenty seconds after the local alarm sounds, the built-in transmitter sends a digitally coded wireless signal to its companion receiver. The wireless signal will be repeated every 20 seconds as long as smoke is still present.

The digital DXS code format features over a million possible codes. The DXS transmitters are precoded at the factory to unique codes, so no field coding is required. The DXS-73 can send three different codes: alarm, test and low battery status.

For versatility, any transmitter can be programmed into any receiver channel. **Receivers must be programmed to the transmitter's code before system testing and operation.** Refer to the receiver's instructions for details on programming.

The unit is powered by a 3-volt lithium battery. The battery is supplied with the transmitter and can power the unit for up to five years. Every hour, the DXS-73 will send a status transmission to the receiver. The hourly signal updates the receiver to the transmitter's condition. By monitoring status transmissions, the receiver can determine if a transmitter has a low battery. If the battery voltage drops below a preset level the alarm will sound low battery beeps and a low battery signal will be sent to the receiver with status reports (some receivers can report low battery status, others cannot).

REMOVE PROTECTIVE COVER

REMOVE PROTECTIVE COVER AND DISCARD

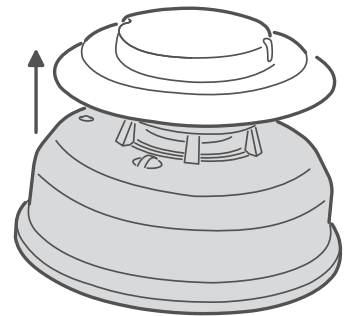

REMOVE MOUNTING PLATE

TWIST MOUNTING PLATE TO UNLOCK

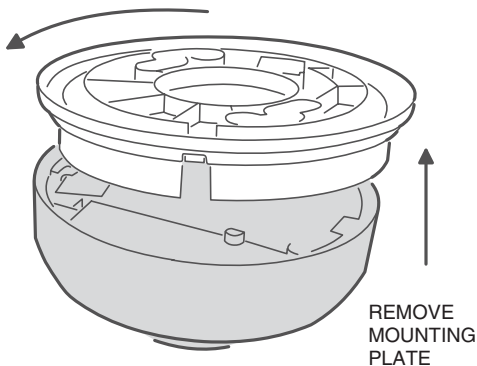

REMOVE BATTERY TAB

REMOVE BATTERY TAB TO APPLY POWER

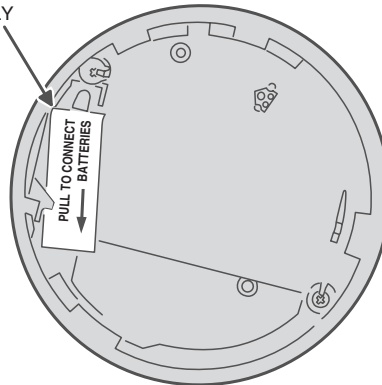

3-VOLT LITHIUM BATTERY TYPES: DURACELL DL123A, PANASONIC CR123A, SANYO CR123A, ADEMCO 466

CHOOSE ALARM LOCATION

READ THE NFPA 72 STANDARD FOR SMOKE ALARM LOCATION ON THE BACK OF THESE INSTRUCTIONS

DETERMINE THE PROPER LOCATION FOR THE ALARM

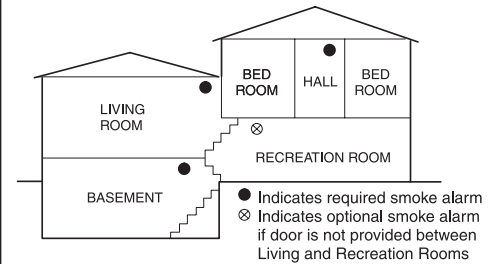

Current studies have shown smoke alarms may not awaken all sleeping individuals, and that is the responsibility of individuals in the household that are capable of assisting others to provide assistance to those who may not be awakened by the alarm sound, or to those who may be incapable of safely evacuating the area unassisted.

INSTALL MOUNTING PLATE

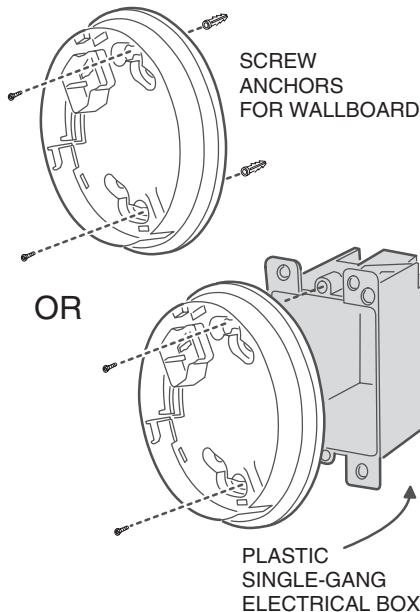

PROGRAM RECEIVER

REFER TO RECEIVER'S INSTRUCTIONS TO PREPARE RECEIVER TO ACCEPT THE TRANSMITTER'S CODE

PRESS AND RELEASE TEST BUTTON TO SEND SIGNAL

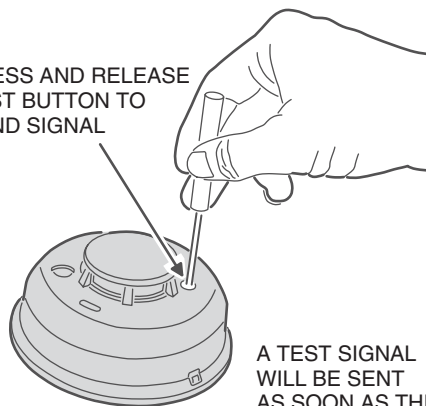

A TEST SIGNAL WILL BE SENT AS SOON AS THE SWITCH IS RELEASED

MOUNT ALARM ON PLATE

MATCH ALIGNMENT TABS IN PLATE WITH TABS IN COVER

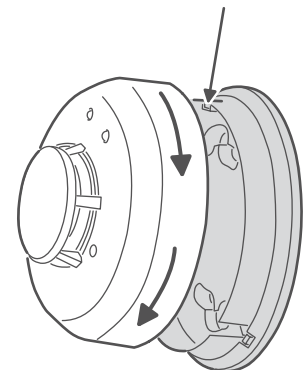

TWIST SMOKE ALARM CLOCKWISE TO LOCK ONTO MOUNTING PLATE

TEST SYSTEM

TO TEST AN ACTUAL FIRE ALARM RESPONSE OF THE SYSTEM, TEST SWITCH **MUST BE HELD FOR 20 SECONDS**

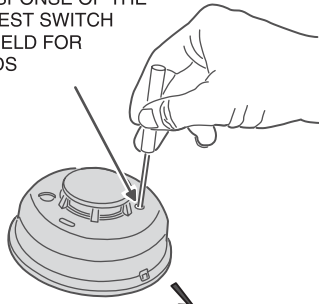

VERIFY THAT RECEIVER ACTIVATES

LED INDICATORS

At Power up = Green/Red blinks every 5 seconds
Standby = Green blinks every 10 seconds
Alarm = Red blinks every 1 second
Maintenance = Red blinks every 5 seconds
Low Battery = Red blinks every 45 seconds

LOW BATTERY CONDITION

When the alarm detects a low battery, the sounder will chirp and the red LED will blink every 45 seconds. The green LED will be off. Pressing the test switch will silence the chirp for 12 hours but will not affect the LEDs. During this silence period, the test switch is disabled. If an alarm condition occurs while the detector is in this chirp silence mode, the alarm will sound. Once the alarm condition has been removed and the detector returns to the standby state, the low battery chirp will resume every 45 seconds.

STANDARD FOR ALARM LOCATION

The DXS-73 should be installed in accordance with National Fire Protection Association (NFPA) Standard 72, which reads as follows:

2-1.1.1 Smoke alarms shall be installed outside of each separate sleeping area in the immediate vicinity of the bedrooms and on each additional story of the family living unit including basements and excluding crawl spaces and unfinished attics. In new construction, a smoke alarm shall be installed in each sleeping room.

2-1.1.2 For family living units with one or more split levels (i.e., adjacent levels with less than one full story separation between levels), a smoke alarm required by 2-1.1.1 shall suffice for an adjacent lower level, including basements. (Exception: Where there is an intervening door between one level and the adjacent lower level, a smoke alarm shall be installed on the lower level.)

- ✓ Ceiling mounted smoke alarms should be located in the center of the room or hall, or not less than 4 inches from any wall. When the alarm is mounted on a wall, the top of the alarm should be 4 to 12 inches from the ceiling.
- ✓ Do not install smoke alarms where normal ambient temperatures are above 100°F (37.8°C), or below 40°F (4°C). Also, do not locate alarm in front of air conditioners, heating registers, or other locations where normal air circulation will keep smoke from entering the detector.

A-2.5.2.1 Smoke Detection - Are More Smoke Alarms Desirable? The required number of smoke alarms might not provide reliable early warning protection for those areas separated by a door from the areas protected by the required smoke alarms. For this reason, it is recommended that the householder consider the use of additional smoke alarms for those areas for increased protection. The additional areas include the basement, bedrooms, dining room, furnace room, utility room, and hallways not protected by the required smoke alarms. The installation of smoke alarms in kitchens, attics (finished or unfinished), or garages is not normally recommended, as these locations occasionally experience conditions that can result in improper operation.

Smoke alarms are not to be used with detector guards unless the combination has been evaluated and found suitable for the purpose.

FIRE PREVENTION AND ESCAPE

The purpose of an early warning smoke alarm is to detect the presence of fire in its early stages, and sound an alarm giving the occupants more time to exit the premise before the smoke reaches a dangerous concentration level.

Fires start even with the best of housekeeping and fire prevention procedures. Fire is an unexpected event. Early warning detection alerts occupants in time to act.

KNOW FIRE HAZARDS. No detection device can protect life in all situations. Therefore, safeguards should be taken to avoid such potentially dangerous situations as: smoking in bed, leaving children home alone, cleaning with flammable liquids such as gasoline.

The best fire protection is minimizing fire hazards through proper storage of materials and general good housekeeping techniques. A cluttered basement, attic, or other storage area is an open invitation to fire.

Careless use of combustible materials and electrical appliances, or overloading of electrical outlets are other prime causes in starting fires.

It is most important that explosive and/or fast burning materials be eliminated from the home, if at all possible.

Even after proper precautions have been taken, fires can start. *Be prepared.*

IN CASE OF FIRE. Leave immediately. Don't stop to pack or search for valuables. In heavy smoke, hold your breath and stay low - crawl if necessary. The clearest air is usually at the floor.

If you have to go through a closed door, carefully feel the door and door knob to see if undue heat is present. If they seem relatively cool, brace your foot against the bottom of the door with your hip against the door and one hand against the top edge. Open it slightly. If a rush of hot air is felt, slam the door quickly and latch it. Unvented fire tends to build up considerable pressure. Be sure all the household realizes and understands this danger.

Use your neighbor's phone or a street fire alarm box. *The job of extinguishing the fire should be left to the professionals. Too many unforeseen things can occur when inexperienced people try to extinguish a fire.*

BE PREPARED. Perform fire drills regularly. Use them to assure recognition of an alarm signal. For your protection, simulate different circumstances (smoke in hall, in living room, etc.). Then have everyone react to the situation.

Draw a floor plan and show two exits from each room. Frequently a knotted rope or ladder from a window will serve this purpose. It is important that children be instructed carefully, because they tend to hide in times of crisis.

It is imperative that one meeting place outside the home be established. You should insist that everyone meet there during an alarm. This will eliminate the tragedy of someone re-entering the house for a missing member who is actually safe.

If you have children and/or invalids residing in your household, you can help your fire department. Most fire departments have window decals available for use in children's or invalid's bedrooms. Properly used, these decals will quickly identify sleeping quarters of these individuals and show the fire department where to look first for members of your household.

- ✓ Additional information on Household Fire Warning is available at nominal cost from: The National Fire Protection Association, Batterymarch Park, Quincy, MA 02269. Request Standard No. NFPA 72

This device complies with FCC Rules Part 15 and Industry Canada Rules & Regulations. Operation is subject to the following two conditions: (1) This device may not cause harmful interference and (2) this device must accept any interference received, including interference that may cause undesired operation.

EXAMPLE ALARM LOCATIONS

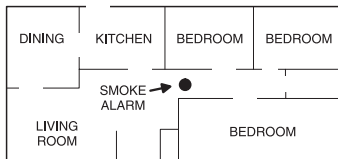

A smoke alarm should be located between the sleeping area and the rest of the family living unit.

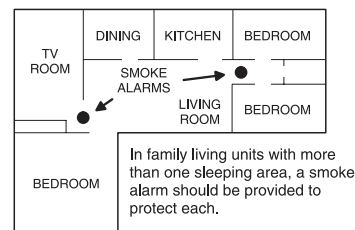

In family living units with more than one sleeping area, a smoke alarm should be provided to protect each.

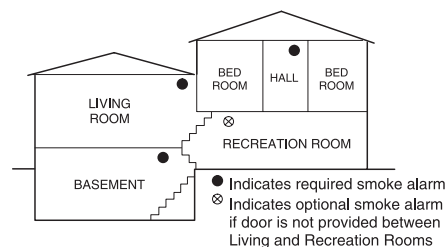

● Indicates required smoke alarm
⊗ Indicates optional smoke alarm if door is not provided between Living and Recreation Rooms

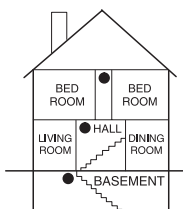

A smoke alarm should be located on each story.

LINEAR LIMITED WARRANTY

This Linear product is warranted against defects in material and workmanship for twelve (12) months. **This warranty extends only to wholesale customers** who buy direct from Linear or through Linear's normal distribution channels. **Linear does not warrant this product to consumers.** Consumers should inquire from their selling dealer as to the nature of the dealer's warranty, if any. **There are no obligations or liabilities on the part of Linear LLC for consequential damages arising out of or in connection with use or performance of this product or other indirect damages with respect to loss of property, revenue, or profit, or cost of removal, installation, or reinstallation.** All implied warranties, including implied warranties for merchantability and implied warranties for fitness, are valid only until the warranty expires. **This Linear LLC Warranty is in lieu of all other warranties express or implied.**

All products returned for warranty service require a Return Product Authorization Number (RPA#). Contact Linear Technical Services at 1-800-421-1587 for an RPA# and other important details

IMPORTANT!!!

Linear radio controls provide a reliable communications link and fill an important need in portable wireless signaling. However, there are some limitations which must be observed.

- * For U.S. installations only: The radios are required to comply with FCC Rules and Regulations as Part 15 devices. As such, they have limited transmitter power and therefore limited range.
- * A receiver cannot respond to more than one transmitted signal at a time and may be blocked by radio signals that occur on or near their operating frequencies, regardless of code settings.
- * Changes or modifications to the device may void FCC compliance.
- * Infrequently used radio links should be tested regularly to protect against undetected interference or fault.
- * A general knowledge of radio and its vagaries should be gained prior to acting as a wholesale distributor or dealer, and these facts should be communicated to the ultimate users.