

# Quik Bridge™ Loop Receiver

Document Number: 466-1568 Rev. B  
January 1999

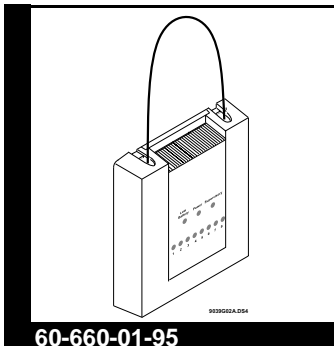

## INSTALLATION INSTRUCTIONS

### Product Summary

The Quik Bridge Loop Receiver (receiver) allows you to use up to 16 Learn Mode wireless sensors (two per zone) with any standard hardwire control panel. In addition, you can use up to 45 Keychain Touchpads and panic button transmitters, for a total of 61 wireless transmitters.

The receiver monitors the alarm, battery, tamper, and supervisory status of transmitters learned into the receiver's eight zones.

The receiver features the following:

- Spatial-diversity receiver, which enhances reception
- 8 programmable zone outputs (N/C or N/O)
- Selectable zone supervision (programmable)
- RF (radio signal) jam detection on zone 7 (optional).
- Receiver cover/ antenna tamper on zone 8 (optional).
- 8 red zone LEDs, which indicate zone openings and closings
- 2 yellow trouble LEDs, which indicate sensor low battery and supervisory conditions
- Support for a piezo (used for RF testing only) which, when used sounds the number of transmissions received from learned transmitters.
- Compatibility with X-10® Modules
- On-board EEPROM that stores sensor IDs and programming information in non-volatile memory, even if power is removed.

### Transmitter Compatibility

- All current ITI Learn Mode™ sensors (319.5 MHz), panic button transmitters, 2- and 4-button Keychain Touchpads.

### Control Panel Compatibility

The receiver is compatible with control panels designed with hardwire loops where the loop negative is ground (common-loop ground).

**CAUTION:** The loop receiver is not directly compatible with powered loops (2-wire smoke detector loops and glass break detector loops). *Connecting the receiver directly to a powered loop can cause permanent damage to the receiver. You must install a relay when connecting to powered loops (see Figure 13).*

The following control panels (one or more versions) support a common-loop ground for one or more of its loops. If your control panel is not listed below, you can test it for compatibility (see "Compatibility Testing" section below).

- ADT SafeWatch®
- Ademco® 4110XM, Vista 10, Via 30P
- C&K® System 236
- DSC® PC1550, DSC Power 832 PC5010
- First Alert® FA 1330C
- Moose® Z1100e
- Napco® Magnum Alert 1008e/M
- Radionics® D9112B

### Compatibility Testing

Typically, hardwire loops have the negative (-) side of the loop common with ground. If this is true and the loop is non-powered, the loop should be compatible with the receiver.

Although most control panels are compatible with the receiver's open collector outputs, *each loop should be tested for compatibility before connecting receiver outputs to the control panel loop inputs.*

**CAUTION:** If the receiver is not directly compatible with a control panel loop, a relay must be used to avoid permanent damage to the receiver.

**To check if the negative side of the loop is common to control panel ground, perform the following test:**

- 1) Turn off or remove control panel power and disconnect the back-up battery.
- 2) Use an ohm meter and measure the resistance between the negative side of the loop and panel ground. If the resistance is zero or close to zero, this loop should be compatible with the loop receiver.

*If the resistance is not zero, a relay is required for this loop.*

**Perform this compatibility test for all loops that are to be connected to the receiver.**

## Overview of Receiver Operation

### DIP Switch

A single DIP switch on the receiver board (see Figure 1) controls the mode of operation. When the DIP switch is up, the receiver is in program mode. When the DIP switch is down, the receiver is in run mode.

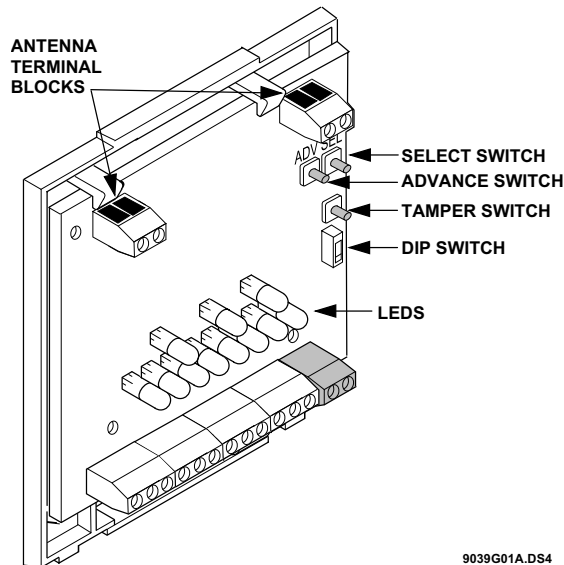

Figure 1. Main Components of the Receiver

## Tamper Switch Function

### In Run Mode

If no transmitters are learned into zone 8, the receiver's tamper switch is active. Tripping the tamper switch (by removing the cover) or removing the antenna causes a tamper alarm on zone 8.

If one or more transmitters are learned into zone 8, the tamper feature is inactive and does not cause an alarm.

### In Program Mode

While in program mode, pressing the tamper switch cycles through three programming areas:

- Learn/Delete Transmitters
- Configuring Zone/Trouble Outputs N/O or N/C
- Enabling/Disabling Zone Supervision

### ADV and SEL Switches

These switches are used only when in program mode.

The ADV (advance) switch lets you cycle to the zone you want to program.

The SEL (select) switch lets you select the zone or trouble output for programming.

### Outputs

The receiver uses open-collector transistors for the zone and trouble outputs (see Figure 2). The outputs can be open (high impedance) or closed (shorted to ground), which can be configured to be normally closed (N/C) or normally open (N/O). Each output can be wired to the control panel.

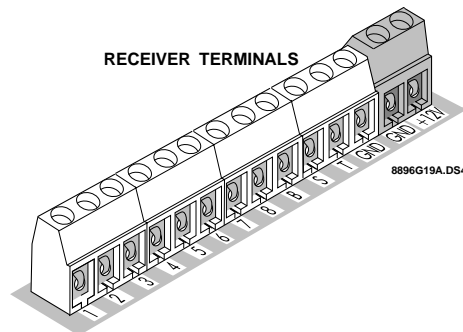

Figure 2. Receiver Terminal Strip

## Zone Outputs

There are eight zone outputs labeled 1 through 8. When a learned transmitter is activated, the corresponding zone output switches to the alarm state and remains in alarm for at least 3 seconds, until the transmitter is restored to its non-alarm state. (If the control panel connected to the receiver is armed, the panel activates an alarm in response to the zone output transition.)

**Zone 7—Receiver Jam Detect:** If no transmitters are learned into zone 7, this output trips whenever the receiver detects a jam condition. Receiver jamming occurs when the receiver detects a constant signal for 30 seconds. The receiver jam detect feature is disabled automatically if transmitters are learned into zone 7.

**Zone 8—Receiver Cover/Antenna Tamper:** If no transmitters are learned into zone 8, this output trips whenever the receiver cover or the antenna is removed. When transmitters are learned into zone 8, these tamper features are disabled.

## Trouble Outputs

There are two trouble outputs labeled **B** (low battery summary) and **S** (supervisory failure summary).

**B - Low Battery:** When a learned transmitter sends a low battery signal, this output switches to, and remains in the alarm state until the receiver receives a signal from the same transmitter with a good battery.

**S - Supervisory:** If a learned supervised transmitter fails to report for **four hours**, this output switches to the alarm state until the failed or unreporting transmitters have reported to the receiver.

## Test Output

**T - Test/Piezo:** This output momentarily supplies 5 VDC each time a transmitter sends an alarm signal to the receiver. Connect a piezo (optional) to this output only when testing RF transmitter response.

## LED Indicators

The receiver has 11 LEDs: 8 red zone LEDs (bottom row), a green Power LED, a yellow Low Battery LED, and a yellow Supervisory LED (see Figure 3).

**Figure 3. Receiver LEDs**

In run mode, the LEDs indicate alarm and trouble conditions. In program mode, the LEDs indicate programming conditions.

## Power LED/Self-Tests

Table 1 describes the power LED states. The power LED turns on after power is applied to the receiver and the self-tests are passed. The LED blinks once each time a signal is received from a transmitter.

If the receiver fails the self-tests, the power LED does not turn on. Instead, the trouble LEDs flash alternately for a failed self-test.

**Table 1. Power LED States**

Power LED	Indicates
On steady	Receiver has power and is functioning normally.
Off (and all other LEDs off)	Receiver is not properly wired or has a power failure.
Off (and yellow LEDs blinking)	Receiver failed power-up test.
Blinks off momentarily	Receiver received an RF signal, whether learned or not.

## Run Mode LED Indications

In run mode, the LEDs indicate 3 conditions: alarm, low battery, and supervisory failure.

### To diagnose alarm/tamper status conditions:

When the trouble LEDs are both off, the zone LEDs indicate alarm/tamper information.

The zone LEDs turn on for zones that are open (in alarm/tamper). Zone LEDs remain off for zones that are closed or not used.

**To diagnose transmitter low battery conditions:**

The yellow low battery LED indicates when one or more transmitters have reported a low battery condition. After a low battery report, the low battery LED will flash or blink once every three seconds, in sync with at least one zone LED. Check the corresponding zone's transmitter(s) for low battery conditions.

**To diagnose transmitter supervisory conditions:**

The yellow supervisory LED indicates when one or more transmitters have failed to report to the receiver for at least four hours. When a supervisory condition exists, the supervisory LED will flash or blink once every three seconds, in sync with at least one zone LED. Check the corresponding zone's transmitter(s) for supervisory conditions.

Figure 4 shows the alarm, low battery and supervisory run mode LED indications.

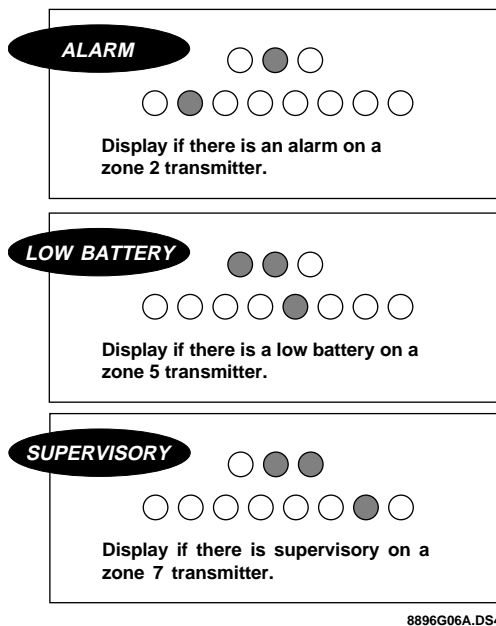

Figure 4. Run Mode LED Indications

**Tools and Accessories Needed**

**Included with Receiver**

- Mounting screws and anchors
- Spring for tamper switch
- 1 antenna

**Not Included with Receiver**

- Phillips screwdriver
- Small standard screwdriver
- 12-22 gauge stranded wire
- Optional piezo for sensor testing (30-006)
- 12 VDC power supply (typically supplied by panel)
- EOL Resistors (typically supplied with panel)

**Installation Guidelines**

Observe the following guidelines when installing the receiver:

- Leave 10" above the receiver for the antenna.
  - Avoid areas that may expose the receiver to moisture.
  - Avoid areas with excessive metal or electrical wiring, including furnace and utility rooms.
- or--* If unavoidable, mount on metal with the antenna extending above the metallic surface (see Figure 5).

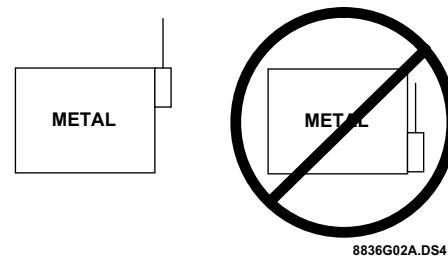

Figure 5. When Mounting on Metal is Unavoidable

**Installing the Receiver**

**Mounting the Receiver**

**CAUTION: You must be free of static electricity before handling circuit boards. Touch a bare metal surface or wear a grounding strap to discharge yourself.**

- 1) Remove the receiver's cover by pressing down on the top center of the cover (see Figure 6.).

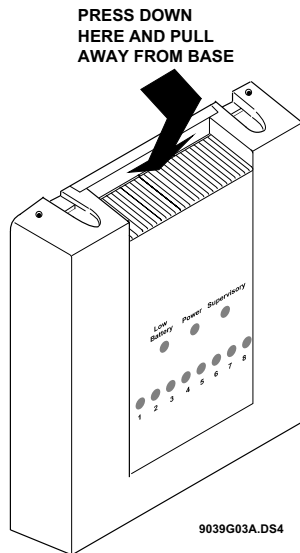

Figure 6. Removing the Receiver's Cover

- 2) Press down on the lower right corner of the base until the lower right latch releases the circuit board (see Figure 7).
- 3) Remove the circuit board by pulling it away from the top two latches and set it aside.
- 4) Hold the base against the mounting surface and mark the three mounting holes (see Figure 7). Leave at least 10" above the base for the antenna.

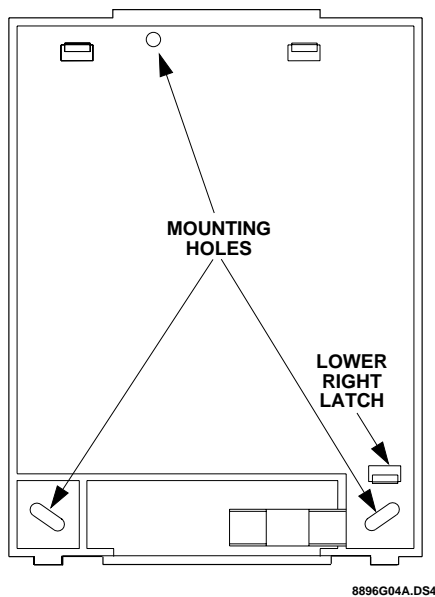

Figure 7. Base Mounting Hole Locations

- 5) Remove the base and install the anchors provided, if studs are not present.
- 6) Mount the base on the wall with the screws provided.
- 7) Replace the circuit board on the base by sliding the top of the circuit board under the top two latches, then press on the bottom of the circuit board until it snaps under the lower right latch.

## Connecting the Antenna to the Receiver

### To connect the antenna to the receiver:

- 1) Loosen the **inside** terminals of the left and right antenna terminal blocks.
- 2) Insert an antenna end into each **inside** terminal.
- 3) Tighten the terminal screws.

## Powering

### To connect power to the receiver:

- 1) Turn off or remove power from the panel and disconnect the battery.
- 2) Wire receiver terminals (GND) and (+12V) to a non-switched 12V supply output on the control panel. Make sure you observe the correct polarity (see Figure 8).

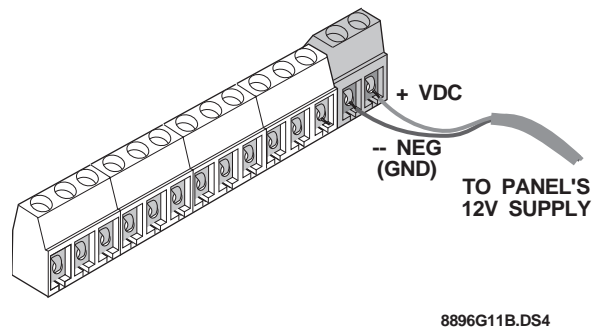

Figure 8. Connecting Panel Power to the Receiver

- 3) Turn on or apply power to the panel.

## Zone Planning

Before programming, it's a good idea to write down how you plan to use the transmitters with each zone.

The following guidelines describe the receiver zone capabilities. Use these guidelines to help you complete Table 2 for recording the wireless devices used

for each zone.

## Zone Planning Guidelines

### Keychain Touchpads

The receiver can learn up to 45 Keychain Touchpads. The following describes the Keychain Touchpad button functions.

Suggested applications include panic button, momentary or maintained (toggle on/off) control panel activation for arming/disarming, or momentary activation for a garage door opener. Maintained output applications also include X-10 light control (see “X-10 Applications”).

**Note:** All Keychain Touchpads learned into the receiver control the same zone outputs. For example, if Keychain Touchpad #1 is learned into zone 1 and Keychain Touchpad #2 is learned into zone 2, both Keychain Touchpads control both zones.

- **Zone 1: Lock & Unlock Buttons Together**—This simultaneous keypress can be learned only into zone 1 and still allows you to learn 2 additional sensors into zone 1. When learned, this keypress causes a momentary alarm on zone 1.

**Note:** Both panic button transmitters and this keypress can be learned into zone 1 together; however, the total number of panic buttons and Keychain Touchpads learned into zone 1 cannot exceed 45.

**Note:** For zones 2 through 6, keychain touchpads and other sensors cannot be learned into the same zone.

- **Zone 2: Lock or Unlock Button**—When learned into zone 2, both of these keypresses work together to provide a maintained (toggle) output response (only one of these buttons needs to be learned for both to work).  
Typically, this output would be used for a maintained keyswitch on the control panel for arming/disarming (refer to the control panel instructions for this application).  
When learned, pressing the lock button arms the system and pressing the unlock button disarms the system.

- **Zone 3: Lights Button**—This keypress can be

learned only into zone 3. When learned, pressing this button switches the zone 3 output. The output can be configured to switch momentarily (default) or maintained (toggle on/off for each press) (See Configuring Touchpad Zone Output Responses).

- **Zone 4: Star Button**—This keypress can be learned only into zone 4. When learned, pressing this button switches the zone 4 output. The output can be configured to switch momentarily (default) or maintained (toggle) (See Configuring Touchpad Zone Output Responses).
- **Zone 5: Lock Button**—This keypress can be learned into zone 2 (as detailed above) or zone 5. When learned into zone 5, pressing this button switches the zone 5 output. The output can be configured to switch momentarily (default) or maintained (toggle) (See Configuring Touchpad Zone Output Responses).
- **Zone 6: Unlock Button**—This keypress can be learned into zone 2 (as above) or zone 6. When learned into zone 6, pressing this button switches the zone 6 output. The output can be configured to switch momentarily (default) or maintained (toggle) (See Configuring Touchpad Zone Output Responses).

### Tamper and Trouble Conditions

- **Zone 7: RF jam detection** is set up to automatically monitor for radio signals that can jam the receiver. However, once a transmitter is learned into zone 7, the RF jam detection is disabled.
- **Zone 8: Cover/Antenna tamper** is set up to automatically monitor cover and antenna removal. However, once a transmitter is learned into zone 8, the cover/antenna tamper is disabled.
- **Low Battery**—Receiver terminal B activates whenever the receiver gets a signal from a transmitter with a low battery. To monitor for low transmitter battery conditions, connect the receiver’s B output to a control panel zone input.
- **RF Supervision**—Receiver terminal S activates whenever the receiver goes four hours without receiving a signal from a supervised transmitter. To monitor for RF supervision, connect the receiver’s S output to a control panel zone input.

## Programming the Receiver

### Panic Buttons and Wireless Sensors

- **Panic Buttons**—Use zone 1 for up to 45 unsupervised panic button transmitters. Use zones 2 - 8 for supervised panic button transmitters (2 per zone).

**Wireless Sensors**—Learn wireless sensors into remaining unused zones (2 per zone). Make sure that both sensors learned into the same zone have the same expected response type at the control panel (i.e. delay, instant, interior, 24-hour).

**Table 2. Transmitter Zone Assignments**

Recvr. Zone	Panel Zone	Transmitter	Function
1		_____	_____
2		_____	_____
3		_____	_____
4		_____	_____
5		_____	_____
6		_____	_____
7 (RF Jam Detect)		_____	_____
8 (Tamper Detect)		_____	_____
B			
S			

This section describes the following programming procedures:

- Learning Wireless Transmitters
- Deleting Wireless Transmitters
- Configuring Zone/Trouble Outputs N/O or N/C
- Configuring RF Supervision
- Configuring Keychain Touchpad Zone Output Responses
- Garage Door Opener Control
- X-10 Applications (Light Control and Garage Door Opener Control)

### Learning Wireless Transmitters

#### To learn a transmitter into a zone:

- 1) Enter program mode by sliding the DIP switch up. The low battery and supervisory LEDs blink back and forth. Zone LEDs turn on if sensors are already learned into those zones.
- 2) Press and release the ADV switch until the desired zone LED turns on. (Pressing and holding the ADV switch advances to the next zone and causes the zone LED to flicker.)
- 3) Press and release the SEL switch once to select this zone for learning transmitters. The zone LED remains on and the low battery and supervisory LEDs stop flashing.
- 4) Trip the transmitter(s):
  - For sensors with tamper switches**, activate the sensor's tamper switch by removing the cover.
  - For sensors without tamper switches**, put the sensor in alarm.

Each time the receiver learns a sensor, the selected zone LED blinks once.

**For Keychain Touchpads:**

  - Zone 1, press the lock and unlock buttons together.
  - Zone 2, press the lock or unlock button.
  - Zone 3, press the lights button.
  - Zone 4, press the star button.
  - Zone 5, press the lock button.
  - Zone 6, press the unlock button.

Each time the receiver learns a Keychain Touchpad button, all zone LEDs with learned Keychain Touchpads blink once.
- 5) To stop learning transmitters in the selected zone, slide the DIP switch down.

Repeat steps 1-4 to learn transmitters into other zones.

## Deleting Wireless Transmitters

---

### To delete all transmitters from a zone:

- 1) Enter program mode sliding the DIP switch up.
- 2) Press and release the ADV switch until the desired zone LED turns on.
- 3) Press and hold the SEL switch for five seconds to delete all transmitters from this zone. The zone LED should turn off.
- 4) Slide the dip switch down to put the receiver in run mode.

### To delete a Keychain Touchpad from the receiver:

Repeat steps 1 - 4, for each button on a Keychain Touchpad button that is learned into a zone. A Keychain Touchpad is deleted only when all learned buttons are deleted from their respective zones.

## Configuring Zone/Trouble Outputs N/O or N/C

---

All 8 zones and both trouble outputs default to N/C, and can be changed to N/O.

### To program a zone output N/O or N/C:

- 1) Enter program mode by sliding the DIP switch up.
- 2) Press the tamper switch once to gain access to configuring zone outputs. The low battery LED should turn on or flash.
- 3) Press and release the ADV switch until the desired zone LED turns on.
- 4) Press and release the SEL switch to change the output configuration to the desired setting (zone LED on = N/C, zone LED off = N/O).
- 5) Repeat steps 3 and 4 for each zone configuration change.
- 6) Slide the DIP switch down to return to run mode.

### To program both trouble outputs N/O or N/C:

- 1) Enter program mode by sliding the DIP switch up.
- 2) Press the tamper switch once to gain access to configuring zone outputs.
- 3) Press and release the ADV switch until all zone LEDs are off (nine presses), to select the trouble outputs.
- 4) Press and release the SEL switch to change the trouble output configuration to the desired setting

(low battery LED on = N/C, low battery LED flashing = N/O).

- 5) Slide the DIP switch down to return to run mode.

## Configuring RF Supervision

---

All 8 zones default to be RF supervised, and can be changed to be unsupervised.

### To enable or disable RF supervision on a zone:

- 1) Enter program mode by sliding the DIP switch up.
- 2) Press the tamper switch twice to gain access to configuring zone supervision.
- 3) Press and release the ADV switch until the desired zone LED turns on.
- 4) Press and release the SEL switch to change the RF supervision configuration to the desired setting (zone LED on = supervised, zone LED off = unsupervised).
- 5) Repeat steps 3 and 4 for each zone configuration change.
- 6) Slide the DIP switch down to return to run mode.

**Note:** Keychain Touchpads are not supervised. Panic Button transmitters learned into zone 1 are not supervised.

## Configuring Keychain Touchpad Zone Output Responses

---

Zone outputs 3 through 6 can be set up to respond by switching momentarily or to maintain (toggle on/off for each activation).

### To change the zone output response to momentary or maintained:

- 1) Enter program mode sliding the DIP switch up.
- 2) Press the tamper switch once to gain access to configuring zone outputs.
- 3) Press and release the ADV switch until the desired zone LED (3 - 6) turns on.
- 4) Press and release the SEL switch to change the zone output response to the desired setting. The selected zone's LED should turn off (maintained) or on (momentary), indicating the current configuration.
- 5) Advance to another programmable option or exit program mode by sliding the DIP switch down.

## Garage Door Opener Control

This section describes how to set up a zone with a relay to control a garage door opener.

### To set up garage door opener control using a relay:

- 1) Learn the star button of a 4-Button Keychain Touchpad into a zone (3-6).
- 2) Configure the zone output as N/O, momentary.
- 3) Connect a relay to the zone output (see Figure 9).

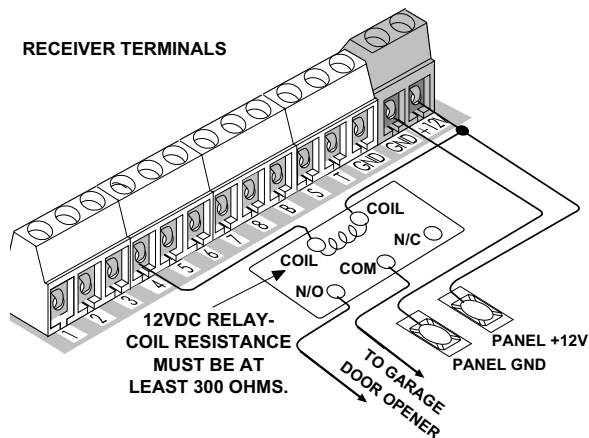

**Figure 9. Connecting a Relay For Garage Door Opener Control**

- 4) Connect the relay COM and N/O contacts to the garage door opener activation terminals.

## X-10 Applications

There are two ways to use X-10 devices:

- Light Control—using an X-10 Powerflash Interface Module (13-058) and X-10 Lamp Modules (13-204), the lights button on a 4-Button Keychain Touchpad can be used to control lights.
- Garage Door Opener Control—using an X-10 Powerflash Interface Module (13-058) and an X-10 Universal Module (13-399), the star button on a 4-Button Keychain Touchpad can be used to control a garage door opener.

## Light Control

### To set up light control:

- 1) Learn the lights button of a 4-Button Keychain Touchpad into zone 3.
- 2) Configure zone 3 for N/O if you want the zone 3 LED to turn on when lights are on, *or--* configure zone 3 for N/C if you want the zone 3 LED to turn on when lights are off.
- 3) Configure zone 3 output as maintained (see Configuring Keychain Touchpad Zone Output Responses).
- 4) Set the unit code and house code dials on the Powerflash Interface Module to match those on the Lamp Module(s).
- 5) Set the Powerflash Interface Module input switch to **B** and the mode switch to **3**.
- 6) Connect receiver terminal 3 to the Powerflash Interface Module's negative (-) terminal.
- 7) Connect the receiver GND terminal to the Powerflash Interface Module's positive (+) terminal.
- 8) Plug in the Powerflash Interface Module and all Lamp Modules.

## Garage Door Opener Control

### To set up garage door opener control using X-10 modules:

- 1) Learn the star button of a 4-Button Keychain Touchpad into a zone (3-6).
- 2) Configure the zone as N/O, momentary.
- 3) Set the unit code and house code dials on the Powerflash Interface Module to match those on the Universal Module.
- 4) Set the Powerflash Interface Module input switch to **B** and the mode switch to **3**.
- 5) On the Universal Module, set the lower-left switch to **momentary** and the lower-right switch to **relay only**.
- 6) Connect the zone output terminal to the Powerflash Interface Module's positive (+) terminal.
- 7) Connect the receiver GND terminal to the Powerflash Interface Module's negative (-) terminal.
- 8) Plug in the Powerflash Interface Module and Universal Module.
- 9) Connect the garage door opener wires to the N/O relay connection on the Universal Module.

## Connecting the Receiver to a Control Panel

There are four ways to wire the loop receiver to the control panel. Refer to Figures 10 through 13 for panel connections.

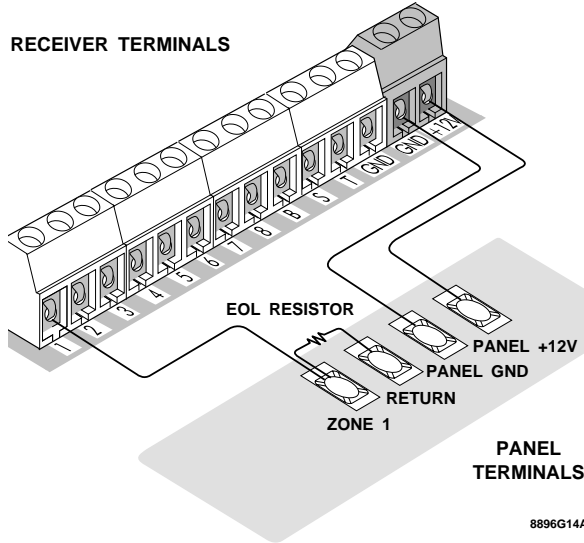

Figure 10. Wiring Diagram for a Supervised N/O Loop

**Note:** You can connect multiple normally open loop receiver zone outputs in parallel to panel zone inputs.

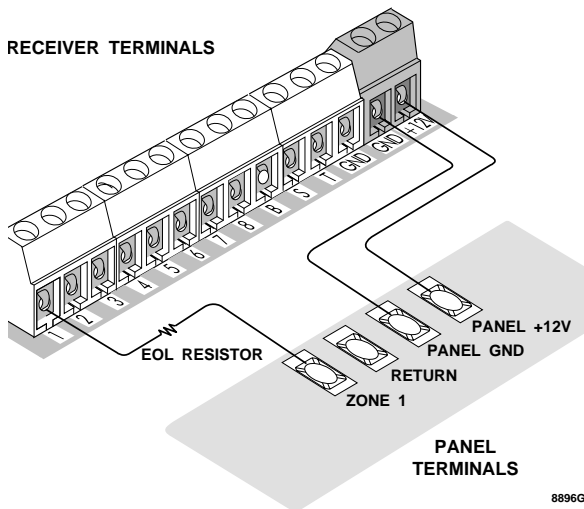

Figure 11. Wiring Diagram for a N/C Loop

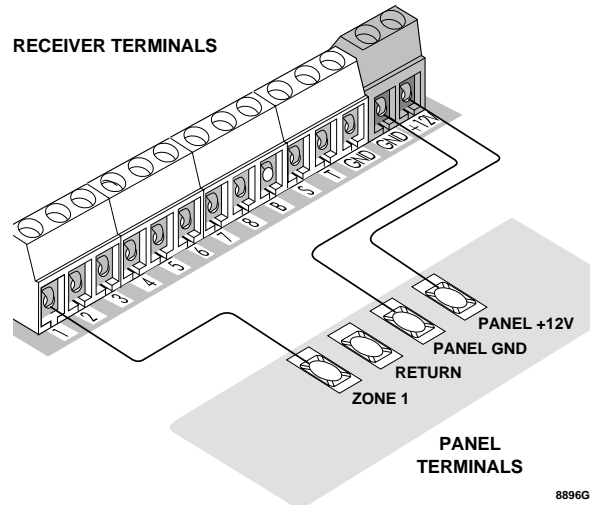

Figure 12. Wiring Diagram for a Nonsupervised Loop

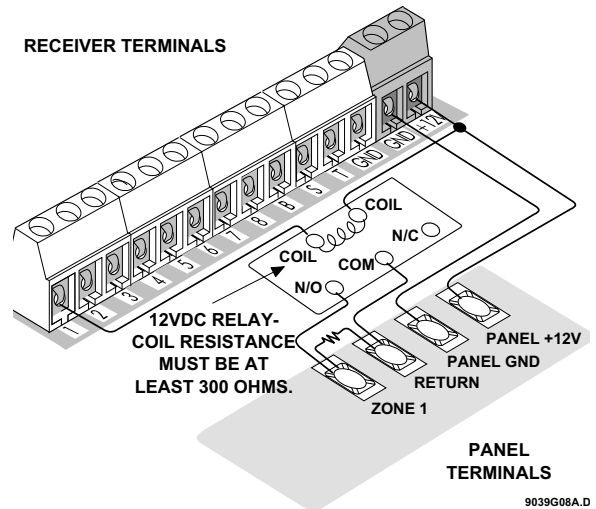

Figure 13. Wiring Diagram when using a Relay

## Testing RF Reception

You can test the receiver two ways: (1) counting the LED flashes when transmitters are tripped or (2) counting the beeps emitted by an attached piezo beeper (optional).

**To test the system using the receiver's LED:**

- 1) Make sure the DIP switch is down (normal operation/run mode).
- 2) Trip all sensors in the system.

- 3) After each trip, watch for the correct number of LED flashes (see Table 3).

**To test the system using a piezo beeper:**

- 1) Connect a piezo (30-006) beeper between the test output (T) and ground (GND) (see Figure 14).

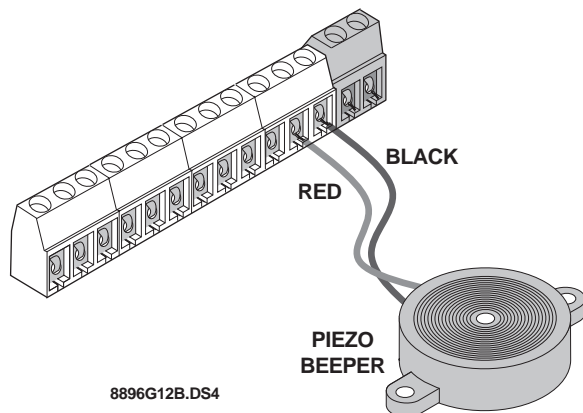

**Figure 14. Piezo Status Beeper Connections**

- 2) Make sure the dip switch is down (normal operation/run mode).
- 3) Trip all sensors in the system.
- 4) After each trip, listen for the correct number of beeps from the piezo beeper (see Table 3).

**Table 3. LED/Piezo Test Responses**

Transmitter		Should Cause
Sensors		7–8 beeps and LED flashes
Keychain Touch-pads	1-Button Press	2 beeps and LED flashes
	2-Button Press	8 beeps and LED flashes

## Specifications

**Compatibility:** Control panels with common-loop ground hardwire loops.

**Power Requirements:** 10.0 – 14.0 VDC

**Current Draw:** 60 mA maximum

**Open Collector Outputs (1-8, B, S):**  
 maximum applied voltage = 16 VDC  
 maximum sink current = 50 mA (typical)  
 15 mA (minimum)

**Operating Temperature Range:** 40° to 120°F

**Dimensions:** 4.125" x 5.25" x 1" (L x W x H), excluding antenna.

## FCC Notices

This equipment has been tested and found to comply with the limits for a class B digital device, pursuant to part 15 of the FCC rules. These limits are designed to provide reasonable protection against harmful interference in a residential installation. This equipment generates, uses, and can radiate radio frequency energy and, if not installed and used in accordance with the instructions, may cause harmful interference to radio communications. However, there is no guarantee that interference will not occur in a particular installation. If this equipment does cause harmful interference to radio or television reception, which can be determined by turning the equipment off and on, the user is encouraged to try to correct the interference by one or more of the following measures:

- Install a quality radio or television outdoor antenna if the indoor antenna is not adequate.
- Reorient or relocate the panel.
- Move the panel away from the affected equipment.
- Move the panel away from any wire runs to the affected equipment.
- Connect the affected equipment and the panel to separate outlets, on different branch circuits.
- Consult the dealer or an experienced radio/TV technician for help.

Send for the FCC booklet *How to Identify and Resolve Radio-TV Interference Problems*, available from the U.S. Government Printing Office, Washington, D.C. 20402.

Stock Number: 004-000-00345-4.

This device complies with FCC Rules Part 15. Operation is subject to the following two conditions:

This device may not cause harmful interference.

This device must accept any interference that may be received, including interference that may cause undesired operation.

Changes or modifications not expressly approved by Interactive Technologies, Inc. can void the user's authority to operate the equipment.



**INTERACTIVE TECHNOLOGIES, INC.**

**2266 SECOND STREET NORTH  
NORTH SAINT PAUL, MN 55109**

**T: 612/777-2690**

**F: 612/779-4890**

**W I R E L E S S**

Security

Automation

Access Control

ITI is a registered trademark of Interactive Technologies, Inc. Quik Bridge and Learn Mode are trademarks of Interactive Technologies, Inc. X-10 is a registered trademark of X-10 (USA), Inc. All other manufacturer and product names are trademarks and/or registered trademarks of their respective names.