



## **dmc1 Rough-In Instructions**

## Introduction

Designed for installation in new home, the dmc1 is a whole-house music communications system. It is designed to provide years of enjoyment and service to the homeowner.

M&S audio products are backed with more than 50 years of experience in the design and manufacture of precision acoustical equipment for the home. To ensure that the homeowners receives the high-quality music and voice reproduction that the system is designed to deliver, it is important that each step of the installation be done carefully. In the event you need troubleshooting assistance, please call our technical staff at 1-800-366-9422.

Prior to installing the dmc1 system, read and observe the Important Safety Instructions on page 2.

Our web address is [www.mssystem.com](http://www.mssystem.com).

# Important Safety Instructions

**READ ALL INSTRUCTIONS CAREFULLY BEFORE  
INSTALLING OR USING THE DMC1 SYSTEM**

**THE dmc1 MUST BE INSTALLED BY A M&S SYSTEMS DEALER OR  
INSTALLERS, AND MUST CONFORM TO ALL LOCAL BUILDING  
AND ELECTRICAL CODES.**

**Warning: always follow these safety instructions.**

**Retain these instructions for future system reference.**

- Read **ALL** safety and operating instructions before installing the dmc1.
- Adhere to all warnings on the dmc1 and in these instructions. Follow all operating and installation instructions.
- **CAUTION:** These installation and servicing instructions are for use by qualified personnel only. To reduce the risk of electric shock, do not perform any servicing other than that contained in the operating instructions unless you are qualified to do so.
- **DO NOT** attempt to service the dmc1 yourself as opening or removing covers may expose you to dangerous voltage or other hazards. Refer all servicing to qualified service personnel.

The lightning flash with arrowhead symbol within an equilateral triangle is intended to alert the user to the presence of uninsulated “dangerous voltage” within the product’s enclosure that may be of sufficient magnitude to constitute a risk of shock to persons.

The exclamation point within an equilateral triangle is intended to alert the user to the presence of important operating and maintenance (servicing) instructions in the literature accompanying the product.

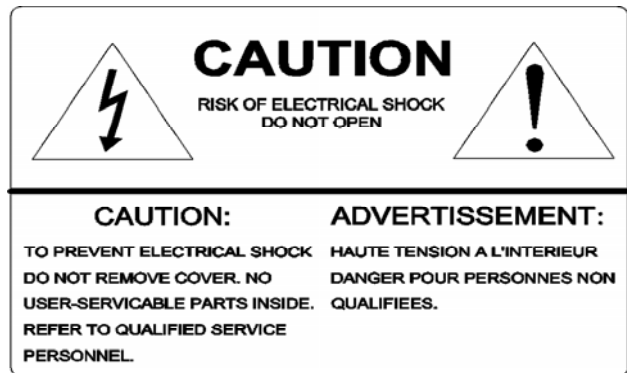

- Locate the system away from heat sources such as radiators, heat registers, stoves, or other heat producing products.
- **Do not** locate the dmc1 master or room stations in an outside wall.
- **Do Not** expose the dmc1 to moisture. Doing so can create fire or shock hazards and impair the warranty.
- **Do not** place the dmc1 master or room stations in any wall cavity with any other electrical wiring in the cavity.
- **Do not** attach devices unauthorized for use with this system. Authorized devices include:
  - Audio components connected via a line level input
  - DMC1CD 6-disc player
- Use only M&S Systems certified replacement parts and have them installed by an M&S Systems dealer or installer. Unauthorized substitutions can result in fire, electric shock, or other hazards.
- Upon completion of any service or product repair, have the M&S Systems dealer or installer conduct a safety check to ensure the system is in proper operating condition.
- Use only a damp cloth to clean the dmc1 master and room stations. Do not use liquid cleaners or aerosol cleaners.

## Cautions: Wiring

- A qualified electrician must run a 120V AC line to the dmc1 transformers.
- USE CAT-5 wire for all DMC1 wire runs excluding the door stations runs. For the door stations we recommend the use of M&S Systems Brand MS4DCXSC wire.
- KEEP CAT-5 wiring separate from any 120/240V wiring, dimmers, security wiring, and other control wiring. Do not allow the CAT-5 wiring to touch any other wiring.
- Individual CAT-5 runs should not exceed more than 350 FEET of wire from any single room station to the dmc1 master or 1000 total feet for the entire system.
- LABEL all wiring runs. Connecting the wires to the dmc1 master, room station or door stations incorrectly may result in system damage.
- Run a single cable from the master unit location to each room station and door station in a "home run" fashion. Do not loop cable from one room station to another.
- DO NOT STAPLE CABLES! Staples cause shorts.
- DO NOT SPLICE CABLES. Splices are unreliable and defeat the signal isolation properties of the cables.
- KEEP CABLES AT LEAST 18 INCHES FROM FLORESCENT LIGHT FIXTURES, DIMMER CONTROLS, AND ALL OTHER WIRING. This includes AC wiring, security cable, and other control wires. These can cause a "hum" or "buzzing" sound.
- KEEP cables away from objects such as heating and air conditioning ducts, metal construction plates, and anything else with sharp edges that can damage the cables.

## Cautions: Room Station Rough-In

Careful consideration should be used when determining the location of the room stations, hub box and line level input locations. **DO NOT** install these devices in the following locations:

- **DO NOT** install room stations in return air ducts.
- **DO NOT** install room stations in exterior walls. Insulation materials will change speaker range and efficiency. Temperature changes in the wall will reduce speaker life.
- **DO NOT** install room stations in saunas. They will not withstand the extreme heat and moisture.
- **DO NOT** install room stations underneath cabinets or over counter tops.
- **DO NOT** install room stations in stud cavities with other wiring or appliances.
- **DO NOT** install room stations within 18" of dimmers, fluorescent light fixtures, security wiring and other control wiring.
- **DO NOT** install room stations within 10 feet of other room stations or the dmc1 master unit. This will cause acoustical feedback.
- **DO NOT** install room stations in stud cavities with other room stations or the dmc1 master unit. This will cause acoustical feedback.
- **DO NOT** install room stations facing other room stations or the dmc1 master unit. This will cause acoustical feedback.
- **DO** make sure all mounting rings are level and oriented as shown in these instructions.

## Rough-In Instructions

The rough-in should be made during new construction prior to the application of wall covering material.

Rough-in boxes are provided for the dmc1 master, door stations and the room stations.

- Tools required:
- Power drill with 1" auger
- #2 Phillips screwdriver
- Wire stripper/cutter
- Tape measure
- Level

## Installing the Wall Housing (DMC1H & DMC1HC)

Locate wall housing DMC1H or DMC1HC (Combo). Position back side of wall housing flush with back of 2X4 stud

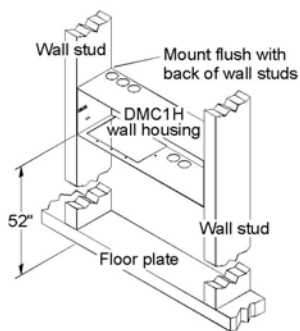
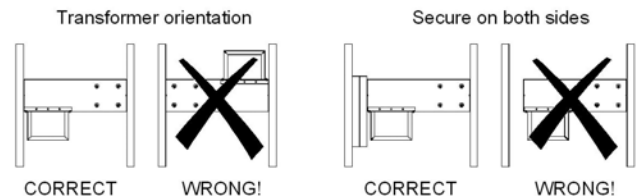

**Figure 2 – Wall housing location**

approximately 52" high for

DMC1H or 45" high for DMC1HC. The housing must be positioned so that the transformers are on the bottom of the wall housing as shown in figure 1.

The wall housing fits between 16" on center (OC) studs, as shown in figure 2. If stud spacing is greater than 16" OC, nail additional sections of wood to provide the necessary support.



**Figure 1 – Transformer location**

Have a qualified electrician run a dedicated 120VAC/60Hz line with ground connection from the power panel to the wall housing as show in figure 3. The dmc1 requires a dedicated power source to assure no interference from other equipment caused by looped power circuits. The ground is necessary for proper radio reception.

Place transformer enclosure from the inside of the wall housing into the transformer enclosure opening at the bottom of the wall housing as shown in figure 4.

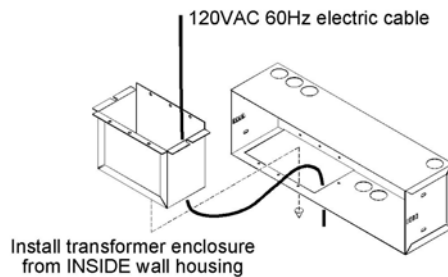

**Figure 4 - Transformer placement**

enclosure to the TE2C transformer enclosure following the same procedure described above and shown in figure 5.

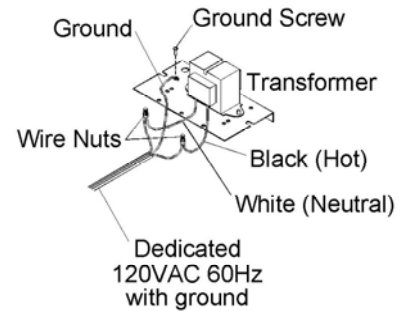

**Figure 3 - Transformer 120VAC/60Hz run**

For the DMC1HC combo wall housing have a qualified electrician loop a power wire from the TE5C transformer

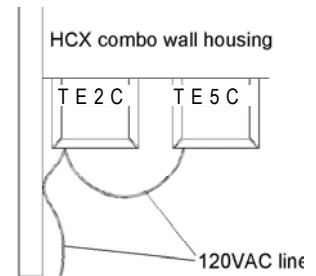

**Figure 5 - dmc1HC transformer connection**

## Antennas

Isolate the antenna leads from the intercom cables by running them through a separate hole in the ceiling plate and in the top of the wall housing as shown in figure 6. If grouped together the intercom cables can shield the antenna leads resulting in poor radio reception. Keep the antenna leads away from metal ductwork and aluminum backed insulation. These can also shield the antenna leads.

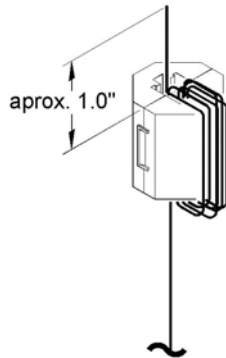

**Figure 7 – Ferrite bead installation**

To install the ferrite bead on the antenna, leave 41" of AM antenna wire in the wall housing. Open the ferrite bead. Grasp wire approximately 1" from the end of the wire. Wrap wire around the bead a minimum of 6 times. Close and latch bead, as shown in figure 7.

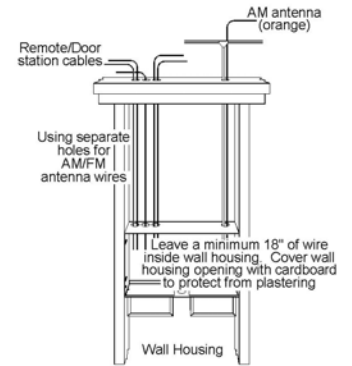
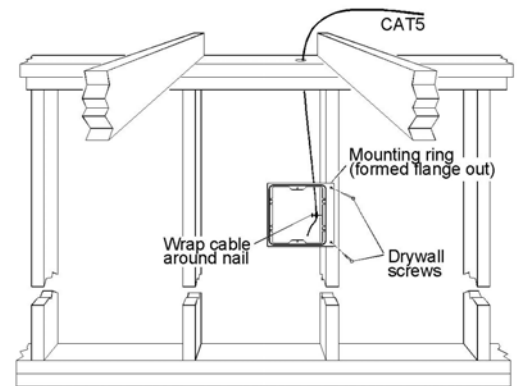

**Figure 6 – Antenna installation**

Note: Failure to install the ferrite bead may cause interference with other electronic devices.

## Speakers

At each room station location nail or screw the DMC1HR mounting ring 52" above the floor as shown in figure 8. From the master wall housing run CAT5 cable to each remote station location. Wrap approximately 12" of excess wire around a nail or screw at the speaker location to protect from dry wall damage. Secure cables at the master.



**Figure 8 - dmc1HR installation**

Important: Please label all cables at both ends. Incorrectly connecting cables to the master, room stations or door stations could result in system damage.

## Patio Speakers

Run a single CAT5 cable from the master location to each outdoor speaker location and secure the cable to the DMC1HRW mounting ring as shown in figure 9.

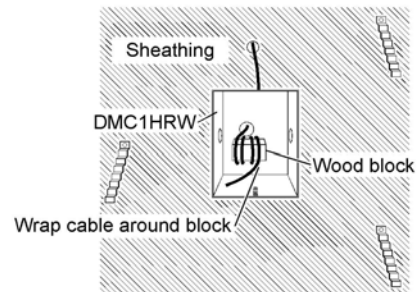

Figure 9 - dmc1HRW installation

Important: Please label all cables at both ends. Incorrectly connecting cables to the master, room stations or door stations could result in system damage.

## Door Stations

Run MS4DCXSC from the master location to each door station. Allow 12" of excess cable on each end. On the door station end, suspend the ME3 metal enclosure on the cable about 50" above the floor (porch) so the brick mason can flush and level it in the brick wall as shown in figure 10. If wood, vinyl, or aluminum siding is used secure surface mount housing SME3D to the finished wall using galvanized screws. Secure cables at master.

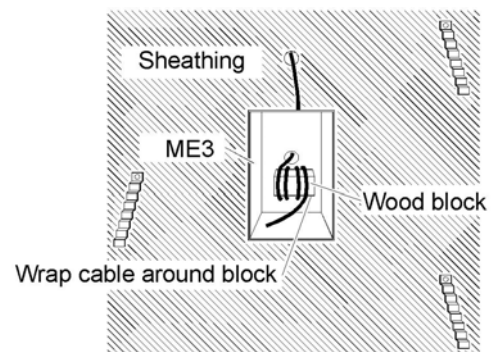

Figure 10 - ME3 installation

Important: Please label all cables at both ends. Incorrectly connecting cables to the master, room stations or door stations could result in system damage.

## External Music Source

Choose a location for the AWP that will be easily accessible to the sources that are to be connected to the system (close to the receiver, TV or DVD player for example). Note the external source wire run to the dmc1 must not exceed 50 feet

At this location, attach a single gang box to a wall stud at a center height of normal wall outlets. Make sure the single gang box extends past the wall stud and into the room so it will be flush with the sheetrock when it is applied. Run the Red and Black shielded audio cables (included in the AWPRX) from the master unit location to the AWP location. Secure the audio cables with a loose knot after they have been pulled through the single gang box. Secure the cables at the master. Label all cables.

## Power Amp Installation – Stereo Upgrade

Run the MS7XSC cable from the dmc1H or dmc1HC wall housing to the remote power amplifier.

Run the MS5XSC cable from the remote amplifier to each volume control. From each volume control, run the MS2SXSC to each respective speaker as shown in figure 11.

The remote power amplifier should be located in a closet or utility closet and should be located within 6 feet of a standard NEMA 5-15R 120VAC receptacle. Install a 1-gang and a 2-gang box at the location for the remote amplifier on a stud. Allocate the 1-gang and 2-gang boxes relative to one another as shown in figure 12. Run all MS5XSC cables from the volume controls to the remote amplifier's 2-gang box.

Run the MS7XSC cable from the dmc1 to the remote amplifier's 1-gang box. The remote amplifier is designed to mount over the 1-gang and 2-gang boxes on a single stud. Note: The speaker cables CANNOT be located in the same gang box used for 120VAC wiring.

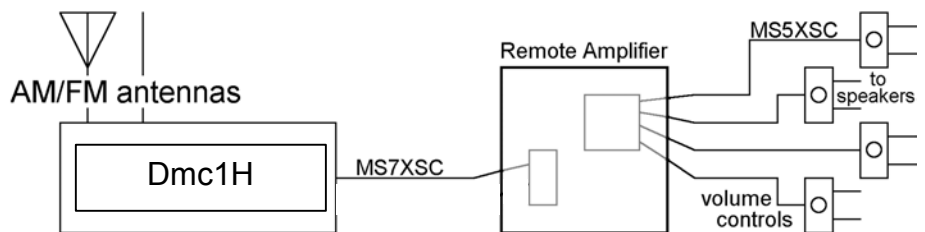

Figure 11 - Power amp wiring

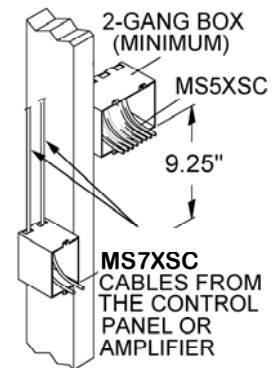

Figure 12 - Power amp installation

Each pair of stereo or mono music speakers is controlled by a single volume control. The volume controls install in a standard single gang box. Run a MS5XSC cable from each volume control location to the remote amplifier. From each volume control location, run a MS2SXSC cable to each satellite speaker (left & right) or mono as shown in figure 13.

Install the appropriate mounting ring for each respective speaker. Follow the instructions included with the speaker for specific dimensions on the mounting ring. Secure the MS2SXSC cable from the speaker's respective volume control to avoid drywall damage.

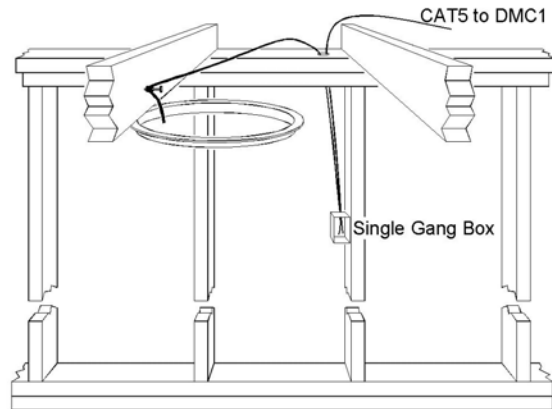

Figure 13 - Speaker installation

## Door Release Options

The door release option is a dry contact closure provided by the dmc1 master. This dry contact is rated 24V at 4 Amps. The sample applications below represent some uses of this option. However, only one application can be used in any dmc1 system at a time.

## Door or Gate Release Mechanism

Run a single line of PBVM127X1 from the DMC1H or DMC1HC housing to the door release mechanism. Connect the red and white wires to the two wire terminals of the door release mechanism.

Run another single line of PBVM127X1 from the DMC1H or DMC1HC housing location to a gang box next to a 120VAC receptacle where the RT11 remote power transformer will be plugged in. Label and secure cables at the housing.

The door release switch contacts are very versatile and can be used with many AC/DC door or switch contacts. Be sure to use the wire and power supply or transformer specified by the door or gate release product being used.

## **Panic Interface with Security System**

Run a line of PBVM127X1 from the DMC1H or DMC1HC housing location to the security control panel. Setup the security panel to receive a normally open dry contact for panic operation. (Refer to programming procedures accompanying the security panel). Label and secure cables at the DMC1H or DMC1HC housing. Have a certified security installer hook the dmc1 up to the alarm system.

## Notes

## M&S Systems 2-Year Warranty

M&S Systems warrants its products to be free of defects for 2 years. Except for the AirVac Gold power units. The warranty period begins on either (a) the date of purchase or installation date of this product or (b) the date of closing on a new residence in which this product was originally installed. The warranty extends to the original user of the product and to each subsequent owner of the product during the term of the warranty. M&S will repair or replace, at its option, parts and materials at no charge. Parts supplied under this warranty may be new or rebuilt at the option of M&S Systems.

If during the warranty period the product appears to have a defect, please call our toll free service number (800-366-9422) prior to dismantling. Dismantling the product prior to calling our service number may void the warranty. Before returning any product to M&S Systems, obtain a Return Authorization Number (RAN) from our service department. M&S Systems will return the repaired product freight prepaid within the continental United States. ANY PRODUCT RETURNED TO M&S SYSTEMS WITHOUT A RAN NUMBER WILL BE REFUSED.

This limited warranty is in lieu of any other warranties, express or implied, including any implied warranty of merchantability or fitness for a particular purpose or otherwise, and of any other obligations or liability on the seller's part. This limited warranty does not cover damage caused by improper installation, acts of God, criminal acts, the violation of applicable building or electrical codes or the use of non-M&S wire, cable (excluding CAT5 and RG-6) or wall housings.

Under no circumstances shall M&S Systems be liable for consequential, incidental or special damages arising in connection with use, or inability to use this product. In no event shall M&S Systems liability hereunder exceed the cost of the product covered hereby. No person is authorized to assume for us or obligate us for any other liability in connection with the sale of this product. Some states do not allow the exclusion or limitation of consequential, incidental or special damages, so the above limitation or exclusion may not apply to you. This limited warranty gives you specific legal rights, and you may also have other rights, which vary from state to state.

115996