

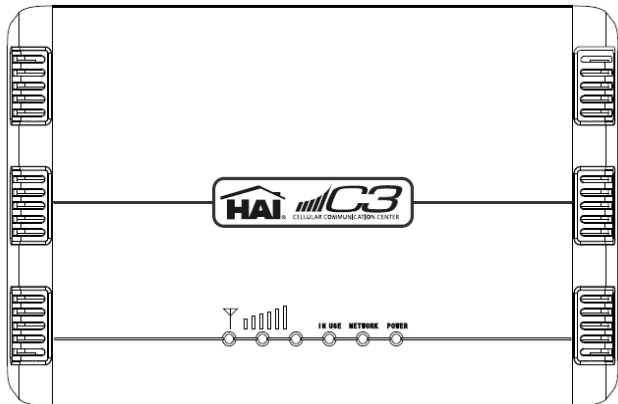

Home Automation, Inc.

Model 70A00-1

GSM Cellular Communications Center



Operation Manual

Document Number 70I00-1 Rev A
August, 2009

Contents

Description	1
Use with security systems.....	1
Everyday use.....	2
Contents of Box.....	3
SIM Card.....	3
Installation	4
Install the Power Adapter.....	4
Installing or Replacing the Battery.....	5
Battery Operation.....	5
Installing the SIM Card.....	6
Connecting Telephones.....	7
Connecting a PSTN Landline.....	8
Operation	9
Making Calls.....	10
Making a call using the GSM network.....	10
When a landline is present.....	10
Receiving Calls.....	11
Ending Calls.....	11
Troubleshooting	11
Specifications	12
Preventing Malfunction	12
Federal Communication Commission Notice:	13
FCC Caution:.....	14
FCC Radiation Exposure Statement:.....	15

Important Safety Instructions:

1. Read all safety and operating instructions before using.
2. This product should not be used near water.
3. Only use dry cloth to clean this product.
4. Do not block any ventilation openings.
5. Do not install this product near any heat sources; such as, radiators, heat registers, stoves, or other appliances (including heat producing amplifiers) that produce heat.
6. Only use attachments specified by the manufacturer.
7. Unplug this apparatus during lightning storms.
8. Care should be taken so that objects do not fall and liquids are not spilled into the unit through the ventilation ports or any other openings.
9. Refer all servicing to qualified service personnel.
10. Servicing is required when the apparatus has been damaged in any way; such as, a liquid has been spilled or objects have fallen into the apparatus, the apparatus has been exposed to rain or moisture, the apparatus does not operate normally, or has been physically damaged.
11. **WARNING:** To reduce the risk of fire or electric shock, do not expose this apparatus to rain or moisture.

WARNING! Battery may explode if mistreated. Do not disassemble or dispose of in fire.

Description

The C3 Cellular Communications Center is a wireless cellular communicator that allows phone calls to be made over the GSM cellular network using the existing telephones in your home. The C3 can be used when there is no landline in your home or the landline is temporarily unavailable.

Use with security systems...

The C3 allows any existing security panel to communicate alarm conditions using the GSM cellular network. The C3 checks the status of the existing PSTN telephone line and if it is unavailable, the C3 will emulate the line signal to the security panel. When an alarm occurs, the security panel will dial out using the GSM cellular network to communicate with the central monitoring station.

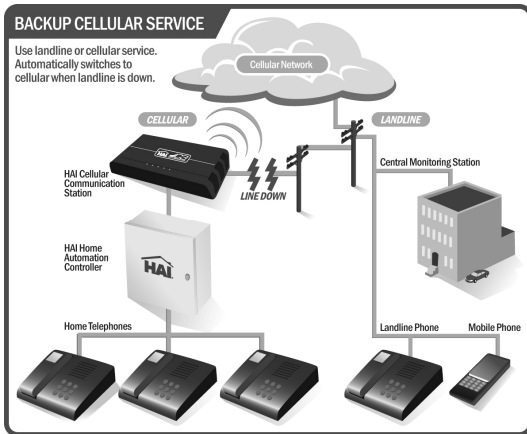

Used as Backup phone service (landline unavailable)

Everyday use...

When the C3 is connected to the GSM cellular network, attached telephones can be used to make calls. If a landline is present, you will hear the normal dial tone and you can make your call as normal using the landline service. However, if the landline is currently unavailable, you will hear a different tone which indicates the C3 is in cellular mode and the call will be made using the cellular network. If the landline is available, but you still want to make the call using the cellular network, when you pick up the phone and hear the normal dial tone, press the '*' key on the phone and the C3 will switch to GSM mode. At that point, you will hear the cellular mode tone and you can make the call using the GSM cellular network.

When a call is made to the phone number assigned to the GSM SIM card that is installed in the C3, any phones that are connected to the C3 will ring as they normally would when a landline call is received.

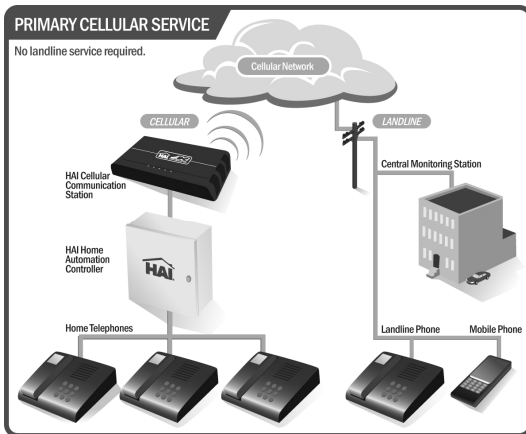

Used as Primary phone service (no landline)

Contents of Box

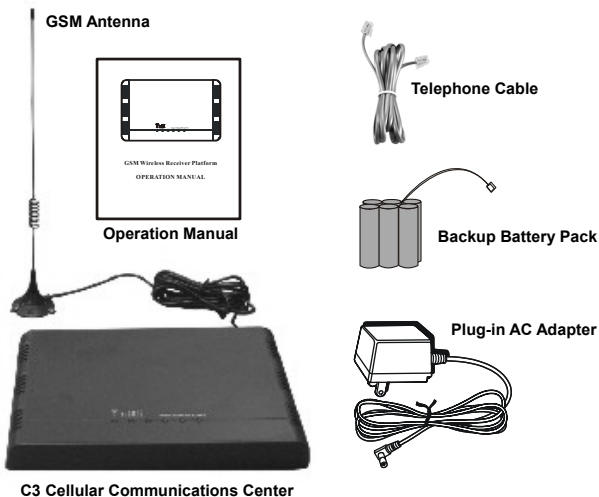

SIM Card

A GSM (Global System for Mobile communications) SIM card (Subscriber Identity Module) is required for operation. The SIM card contains subscriber information about your cellular service including the telephone number.

Typically, an additional line can be added to a GSM cellular plan by your provider for a nominal monthly fee. You can use the SIM card from the additional line in the C3 unit. Another option is to use a prepaid SIM card. Prepaid SIM cards can be used in the C3 as long as the SIM card isn't locked to a handset.

Installation

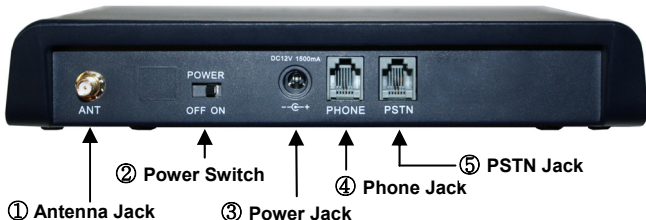

- ① **Antenna Jack (SMA):** Connects the supplied antenna
- ② **Power Switch:** Turns the unit On or Off
- ③ **Power Jack:** Connects the 12V Power Adapter
- ④ **Phone Jack:** Connects to house telephones or alarm panel
- ⑤ **PSTN Jack:** Connects to PSTN telephone line

Install the Antenna

- 1) Screw the antenna onto the antenna base.
- 2) Attach the SMA connector of the base to the C3 Antenna Jack.
- 3) Locate the antenna away from the C3.
- 4) Completely uncoil the antenna cable to avoid interference.

Warning: Do not mount the antenna outdoors.

Install the Power Adapter

Plug the connector from the supplied AC Power Adapter into the C3 Power Jack.

Plug the AC Power Adapter into a 120VAC outlet.

Installing or Replacing the Battery

- 1) If applicable, remove the battery compartment door screw located on the battery door tab.
- 2) Open the battery compartment by pressing down on the battery door tab and removing the battery compartment door.
- 3) If applicable, remove the battery pack by disconnecting the battery cable from the battery connector.
- 4) Install the battery pack by connecting the battery cable to the connector on the inside of the battery compartment.
- 5) Reinstall the battery compartment door using the screw to secure the battery door tab.

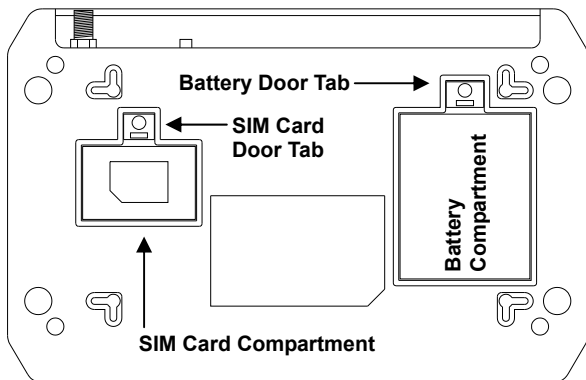

Battery Operation

The C3 unit will automatically switch from AC to battery power upon loss of AC power. Whenever AC power is present, the rechargeable battery pack is being charged.

The rechargeable NI-MH 7.2V, 1300mAh battery pack will provide 3 hours continuous talk-time and 14 hours stand-by operation.

Installing the SIM Card

Caution: The C3 must be switched off before installing or removing the SIM card. Do not install or remove the SIM card when the power is on; otherwise the SIM card may be damaged. The GSM network cannot be used if the SIM card is damaged.

- 1) If applicable, remove the SIM card compartment door screw located on the SIM card door tab.
- 2) Open the SIM card compartment by pressing down on the SIM card door tab and removing the SIM card compartment door.
- 3) Open the SIM card holder by sliding the holder to the right and then lifting up the holder.
- 4) Slide the SIM card into the SIM card holder making sure that the notched corner of the SIM card lines up with the notched corner on the SIM card holder.

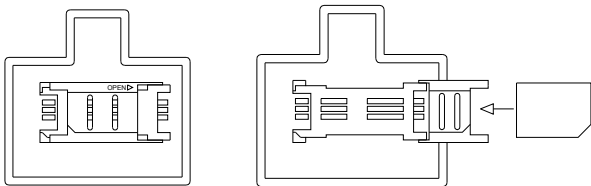

- 5) Gently lower the SIM card holder and lock it in the closed position by sliding the holder to the left.

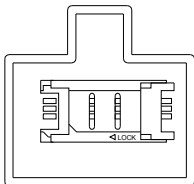

- 6) Reinstall the SIM card compartment door using the screw to secure the SIM card door tab.

Connecting Telephones

Connect analog telephone(s) to the modular jack labeled “PHONE” on the C3 unit. If a PSTN landline isn't present, the GSM network can be used as the primary telephone service.

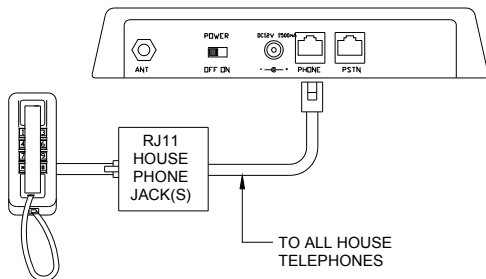

Primary GSM service without a security system

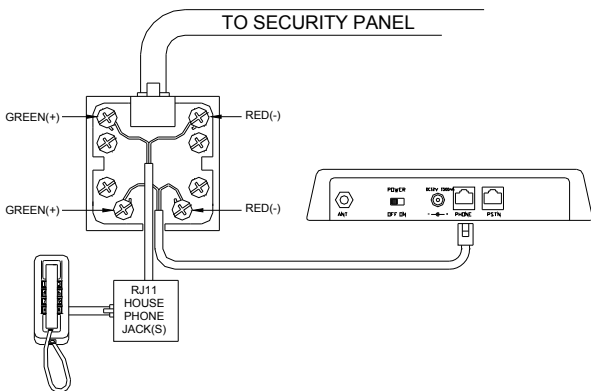

Primary GSM service with a security system

Connecting a PSTN Landline

Connect the incoming PSTN landline to the modular jack labeled "PSTN" on the C3 unit. If a PSTN landline is present, the GSM network is used to backup the PSTN telephone service. If the landline service is unavailable, the GSM network will be used.

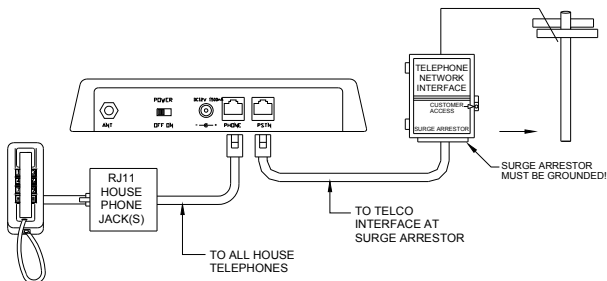

Backup GSM service without a security system

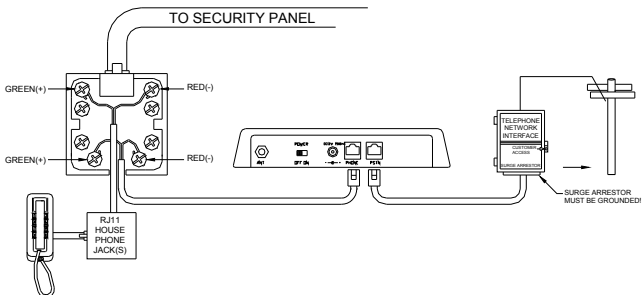

Backup GSM service with a security system

Operation

Turn on the unit by moving the Power Switch to the “On” position. When the unit is first switched on, the C3 unit searches for a network before calls can be made.

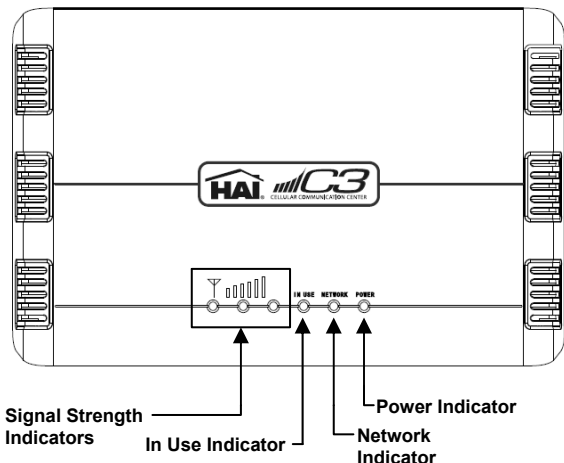

When the unit is turned on, the Power Indicator will illuminate and the Network Indicator will flash quickly while the C3 searches for a network. When a network is found, the Network Indicator will flash slowly and the Signal Strength Indicators will illuminate based on the GSM signal strength.

If the SIM card is not installed or the SIM card can't be used, the Signal Strength Indicators and Network Indicator will flash quickly. If a connected phone is taken off-hook, a busy signal will be heard.

Note: If the SIM card is not installed or can't be used, turn the Power Switch to “Off” so that the landline can be used as normal.

Making Calls

To make a phone call, simply pick up a connected telephone and listen for a dial tone. Whenever a connected phone is taken off-hook, the In Use Indicator is illuminated.

If a PSTN landline is connected, you will hear the normal dial tone. Simply make your call as normal. If the landline is temporarily unavailable, the C3 will automatically switch to GSM mode.

If a PSTN landline is not present or is temporarily unavailable, the GSM network will be used. You will hear a dial tone with a different cadence from the normal PSTN dial tone. When you hear this dial tone, you know that the PSTN landline is currently unavailable and you are using the GSM network.

When connected to a security system and an alarm occurs, the call will be made using the GSM network as if using the PSTN landline.

Making a call using the GSM network

- 1) Pick up the phone and listen for the GSM dial tone.
- 2) Dial the phone number you wish to call and then press the '#' key on the phone keypad. The call will be made immediately.

Note: If you do not press the '#' key after dialing the phone number, the call will automatically be made several seconds after the last digit was entered.

When a landline is present

If you would like to make a phone call using the GSM network even when a PSTN landline is available, you may do so as follows:

- 1) Pick up the phone and listen for the normal dial tone.
- 2) Press the '**' key on the phone keypad.
- 3) You will immediately hear the GSM dial tone.
- 4) Dial the phone number you wish to call as described above.

Receiving Calls

When a call is made to either the landline phone number or the cellular number assigned to the SIM card, the connected phones will ring as normal. Simply pick up a handset to answer the call.

Ending Calls

While on a call using either the landline or the GSM network, to disconnect the call, simply hang up the handset.

Troubleshooting

Symptom	Problem
Always hear busy signal when the phone is off-hook	SIM card is not installed or the SIM card is not making a proper connection with the contacts on the SIM card holder.
Can not connect with GSM network	<ul style="list-style-type: none">■ Reorient the antenna.■ Signal too weak at location.
Signal Strength Indication is weak	<ul style="list-style-type: none">■ Reorient the antenna.■ Antenna is connected improperly.
No dial tone	Telephone line is improperly connected.
Noise during calls	Signal too weak.
Unit unexpectedly shut down	Unit needs to be rebooted. Switch off the power and wait a moment, then restart it.
Echo during calls	<ul style="list-style-type: none">■ Change antenna location.■ Network problem. Please consult with network operator.

Specifications

Operating Temperature: -10°C - +40°C

Noise: not to exceed 60dB (A)

Humidity: 5% - 95% relative humidity, non-condensing

Atmosphere Pressure: 86 - 106KPa

Input Voltage: 100 – 240VAC

Operating Power: DC 12V, 1500mA

Frequency: GSM/GPRS 850/ 900/1800/1900MHz

Power Output:

--Class 4 (2W @ 850/900MHz)

--Class 2 (1W @1800/1900MHz)

Channel Interval: 200 KHz

Receive Sensitivity: -100dBm

Frequency Error: ≤0.1ppm

Dimensions: 8.625" x 5.5" x 1.5"

Preventing Malfunction

- Avoid using, placing or storing the equipment in places subject to strong sunlight or high temperatures. Exposure to intense sunlight and heat may cause the battery to leak, overheat or explode, resulting in fire, burns or other injuries. High temperatures may also cause deformation of the casing. Ensure that there is good ventilation when using the equipment.
- Do not store the equipment in humid or dusty areas. Storage in such areas could lead to fire, electrical shock, or other damage.
- Do not operate beyond its specified temperature, humidity, or power source ratings. Do not use this device in a high temperature or high humidity area.

Federal Communication Commission Notice:

This equipment complies with Part 68 of the FCC rules. Located on the equipment is a label that contains, among other information, the ACTA registration number and ringer equivalence number (REN). If requested, this information must be provided to the telephone company.

The REN is used to determine the quantity of devices which may be connected to the telephone line. Excessive REN's on the telephone line may result in the devices not ringing in response to an incoming call. In most cases, but not all areas, the sum of the REN's should not exceed five (5.0). To be certain of the number of devices that may be connected to the line, as determined by the total REN's, contact the telephone company to determine the maximum REN for the calling area.

This equipment cannot be used on the telephone company-provided coin service. Connection to Party Line Service is subject to State Tariffs.

If this equipment causes harm to the telephone network, the telephone company will notify you in advance that temporary discontinuance of service may be required. If advance notice isn't practical, the telephone company will notify the customer as soon as possible. Also, you will be advised of your right to file a complaint with the FCC if you believe it is necessary.

The telephone company may make changes in its facilities, equipment, operations, or procedures that could affect the operation of the equipment. If this happens, the telephone company will provide advance notice in order for you to make the necessary modifications in order to maintain uninterrupted service.

If trouble is experienced with this equipment, please contact:

Home Automation, Inc.
4330 Michoud Blvd.
New Orleans, LA 70129, USA
Phone: 504-736-9810
Fax: 504-253-2957

If trouble is causing harm to the telephone network, the telephone company may request you to remove the equipment from the network until the problem is resolved.

This equipment uses the following USOC jacks: RJ11C

It is recommended that the customer install an AC surge arrester in the AC outlet to which this device is connected. This is to avoid damaging the equipment caused by local lightning strikes and other electrical surges.

FCC Caution:

Any Changes or modifications not expressly approved by the party responsible for compliance could void the user's authority to operate the equipment.

This device complies with part 15 of the FCC Rules. Operation is subject to the following two conditions: (1) This device may not cause harmful interference, and (2) this device must accept any interference received, including interference that may cause undesired operation.

IMPORTANT NOTE:

FCC Radiation Exposure Statement:

This equipment complies with FCC radiation exposure limits set forth for an uncontrolled environment. This equipment should be installed and operated with a minimum distance of 50cm between the radiator and your body.

This transmitter must not be co-located or operating in conjunction with any other antenna or transmitter.

Note: This equipment has been tested and found to comply with the limits for a Class B digital device, pursuant to part 15 of the FCC Rules. These limits are designed to provide reasonable protection against harmful interference in a residential installation. This equipment generates, uses, and can radiate radio frequency energy and, if not installed and used in accordance with the instructions, may cause harmful interference to radio communications. However, there is no guarantee that interference will not occur in a particular installation. If this equipment does cause harmful interference to radio or television reception, which can be determined by turning the equipment off and on, the user is encouraged to try to correct the interference by one or more of the following measures:

- Reorient or relocate the receiving antenna.
- Increase the separation between the equipment and receiver.
- Connect the equipment into an outlet on a circuit different from that to which the receiver is connected.
- Consult the dealer or an experienced radio/TV technician for help.

